

ALLIGATOR[®]



2015 PRODUCT CATALOG

MORE CONTROL



2015 NEW ALLIGATOR SECTION

For a long term strategy, ALLIGATOR is producing high level, high Tec, high quality and high performance hydraulic brake system and other performance parts. In addition, parts that are made by Alligator will be reusable and more Eco-friendly.

ALWAYS CREATE BETTER SECTION

ALLIGATOR production will focus on the safety, smoothest, reliable, light weight and Eco-friendly. In fact, ALLIGATOR will keep developing and improving all products for customers to control better.

AIMING THE TARGET AND NEVER LET GO

For more than 35 years experiences, we are responsible for the products we make, proud with the quality as we supply to many countries around the world. As ISO 9001/TS 16949 company we commitment that we offer to you with the quality and all the products are testing under extreme conditions. With the innovation and creative products we have, such as i-Link this is why Alligator always moving forward and stand up in front of the crowd and aside other rivals.



CONTENTS

06	DIY HYDRAULIC HOSE KIT
12	HYDRAULIC HOSE FITTINGS AND ACCESSORIES
19	ROTORS
29	CALIPER ADAPTER
31	CENTER-LOCK ADAPTER
32	MECHANICAL DISC BRAKE SYSTEM
33	DISC BRAKE PADS
44	BRAKE SHOES
56	INNER CABLES
61	ALLIGATORILINK™ CABLE KIT
66	DIY CABLE KIT
73	CABLE HOUSING
76	CLEANING AND LUBRICATION
79	TOOLS
86	BRAKE FLUID
87	PARTS AND ACCESSORIES
100	SPECIAL CABLES AND WIRES
101	TEAM AND RACERS



56 31-STRAND SUPERIOR SHINE SLICK STAINLESS INNER CABLE

Stronger, Softer, Anti-Scratch, Smoother and More Flexible
The BEST inner wire in the world, the BEST choice for your
Brake & Shift

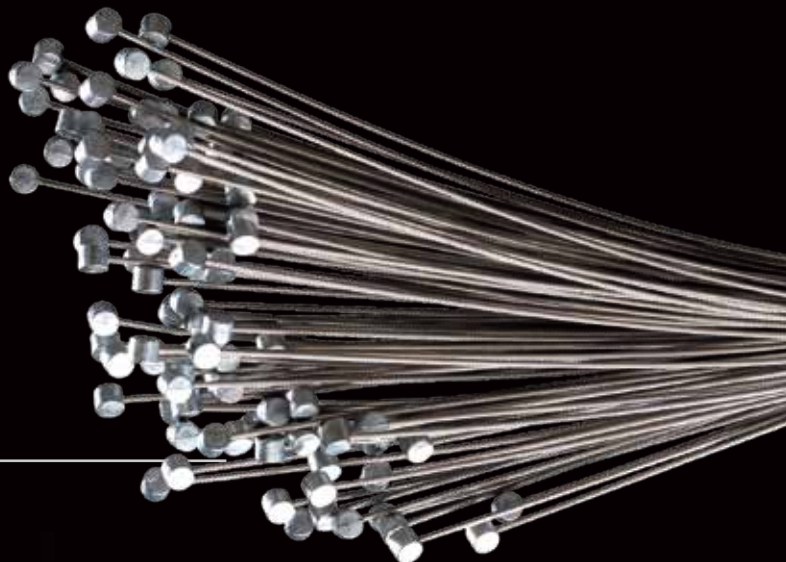

61 ALLIGATORILINK™ The Lightest in the world!

The champion of Tour de France 2010 and many racers' favorite!
Becoming a shining star with ALLIGATORILINK!
Much lower friction than normal housings, makes your shift smoother.
Reduce internal force caused by twisting, protect your inner wire!
Dustproof, Waterproof, All-weather available!

71 11-SPEED CABLE HOUSING

ALLIGATOR changed the structure of SP housing!
Makes it much smoother and sensitive for shifting

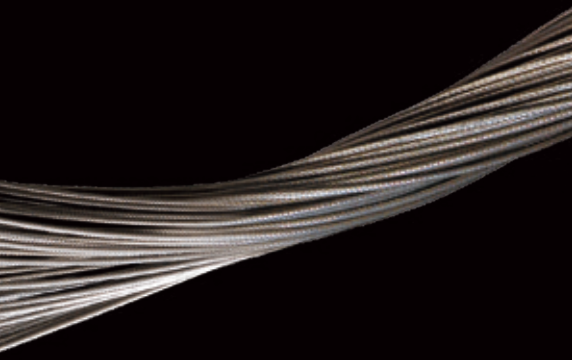

33 COOL SERIES DISC BRAKE PADS

Reliable organic compound pads.
Multiple alloy heat sink pillar helps heat dissipate quickly.

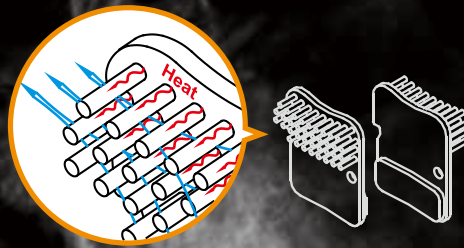

79 PORTABLE MELTING CUTTER SET

The Melting Cutter, Electrical Control Box, Cleaner

- 3 second cutting.
- Wires won't split after cutting.
- Easy to use and portable.
- Easy to clean with Cleaner.
- Available for Stainless and Galvanized inner cables.



82 ANCHOR HYDRAULIC HOSE CUTTER

Better and safer tool to use, save your energy from pressing too hard!
Providing accurate cutting precision, smooth surface after cutting!







SUPER SUPREME™ ø5.5MM

Dupont's P.T.F.E. underlay re-inforced with braided Kevlar brand fiber and strengthened with AISI 304 stainless steel wire mesh plus a scratch resistant cover.
 Minimum bursting strength of 1000 Bar (15,000 PSI) (approx.)
 Temperature range of -40°C to +240°C
 Minimum tensile strength of 450 Kgs (approx.)

DIY kit Includes 3 meter hydraulic hose, connector and accessories for full bike.



ITEM No.	COLOR	COMPATIBILITY	FITTING AND ACCESSORIES
HK-SSU021	CLEAR BLUE	SHIMANO/ HAYES/ AVID/ HOPE/ FORMULA/ GIANT/ Most of MAGURA(without MT4, MT6,MT8)	
HK-SSU021SB	SMOKE-BLACK		
HK-SSU021RD	RED		
HK-SSU021BL	BLUE		
HK-SSU021YW	YELLOW		
HK-SSU022	CLEAR BLUE	Most of MAGURA(without MT4,MT6,MT8)/ AVID/ GATORBRAKE/	
HK-SSU022SB	SMOKE-BLACK		
HK-SSU022RD	RED		
HK-SSU022BL	BLUE		
HK-SSU022YW	YELLOW		
HK-SSU023	CLEAR BLUE	HAYES	
HK-SSU023SB	SMOKE-BLACK		
HK-SSU023RD	RED		
HK-SSU023BL	BLUE		
HK-SSU023YW	YELLOW		
HK-SSU024	CLEAR BLUE	SHIMANO	
HK-SSU024SB	SMOKE-BLACK		
HK-SSU024RD	RED		
HK-SSU024BL	BLUE		
HK-SSU024YW	YELLOW		
HK-SSU0T5	CLEAR BLUE	HOPE/ FORMULA/ GIANT	
HK-SSU0T5SB	SMOKE-BLACK		
HK-SSU0T5RD	RED		
HK-SSU0T5BL	BLUE		
HK-SSU0T5YW	YELLOW		

SUPREME™ \varnothing 5.5MM

Polymer underlay re-inforced with braided Kevlar brand fiber and strengthened with AISI 304 stainless steel wire mesh plus a scratch resistant cover.

Minimum bursting strength: 1000 Bar (15,000 PSI) (approx.)

Temperature range of -40°C to +120°C

Minimum tensile strength of 450 Kgs (approx.)

DIY kit Includes 3 meter hydraulic hose, connector and accessories for full bike.



ITEM No.	COLOR	COMPATIBILITY	FITTING AND ACCESSORIES
HK-SU021	 CLEAR BLUE	SHIMANO/ HAYES/ AVID/ HOPE/ FORMULA/ GIANT/ Most of MAGURA(without MT4, MT6, MT8)	
HK-SU022	 CLEAR BLUE	Most of aMAGURA(without MT4, MT6, MT8)/ AVID/ GATORBRAKE/	
HK-SU023	 CLEAR BLUE	HAYES	
HK-SU024	 CLEAR BLUE	SHIMANO	
HK-SU075	 CLEAR BLUE	HOPE/ FORMULA/ GIANT	



DIY HYDRAULIC HOSE KIT

ULTIMATE™ ø5 MM

Polymer underlay re-inforced with braided polyester fiber.
 Bursting strength of 450 Bar (6,500PSI) (approx.)
 Temperature range of -40°C to +120°C
 Tensile strength of 250kgs. (approx.)

DIY kit Includes 3 meter hydraulic hose, connector and accessories for full bike.



ITEM No.	COLOR	COMPATIBILITY	FITTING AND ACCESSORIES
HK-UL5021	BLACK	SHIMANO/ HAYES/ AVID/ HOPE/ FORMULA/ GIANT/ Most of MAGURA(without MT4, MT6,MT8)	
HK-UL5021WH	WHITE		
HK-UL5021RD	RED		
HK-UL5021BL	BLUE		
HK-UL5022	BLACK	Most of MAGURA (without MT4,MT6,MT8)/ AVID/ GATORBRAKE/	
HK-UL5022WH	WHITE		
HK-UL5022RD	RED		
HK-UL5022BL	BLUE		
HK-UL5023	BLACK	HAYES	
HK-UL5023WH	WHITE		
HK-UL5023RD	RED		
HK-UL5023BL	BLUE		
HK-UL5024	BLACK	SHIMANO	
HK-UL5024WH	WHITE		
HK-UL5024RD	RED		
HK-UL5024BL	BLUE		
HK-UL50T5	BLACK	HOPE/ FORMULA/ GIANT	
HK-UL50T5WH	WHITE		
HK-UL50T5RD	RED		
HK-UL50T5BL	BLUE		
HK-UL5026	BLACK	For MAGURA M4, M6, M8	
HK-UL5026WH	WHITE		
HK-UL5026RD	RED		
HK-UL5026BL	BLUE		

SPECIAL COLORS : YELLOW (YW) GREEN (GN) PINK (PK) MAXXIS ORANGE (MO)

Min. Q'ty : 50 SET PER ITEM.

ULTIMATE™ ø5.5 MM

Polymer underlay re-inforced with braided polyester fiber.
 Bursting strength of 450 Bar (6,500PSI) (approx.)
 Temperature range of -40°C to +120°C
 Tensile strength of 250kgs. (approx.)

DIY kit Includes 3 meter hydraulic hose, connector and accessories for full bike.



ITEM No.	COLOR	COMPATIBILITY	FITTING AND ACCESSORIES
HK-UL021	BLACK	SHIMANO/ HAYES/ AVID/ HOPE/ FORMULA/ GIANT/ Most of MAGURA(without MT4, MT6,MT8)	
HK-UL021WH	WHITE		
HK-UL021RD	RED		
HK-UL021BL	BLUE		
HK-UL022	BLACK	Most of MAGURA (without MT4,MT6,MT8)/ AVID/ GATORBRAKE/	
HK-UL022WH	WHITE		
HK-UL022RD	RED		
HK-UL022BL	BLUE		
HK-UL023	BLACK	HAYES	
HK-UL023WH	WHITE		
HK-UL023RD	RED		
HK-UL023BL	BLUE		
HK-UL024	BLACK	SHIMANO	
HK-UL024WH	WHITE		
HK-UL024RD	RED		
HK-UL024BL	BLUE		
HK-UL0T5	BLACK	HOPE/ FORMULA/ GIANT	
HK-UL0T5WH	WHITE		
HK-UL0T5RD	RED		
HK-UL0T5BL	BLUE		

SPECIAL COLORS : YELLOW (YW) GREEN (GN) PINK (PK) MAXXIS ORANGE (MO)

Min. Qty : 50 SET PER ITEM.

30M HYDRAULIC HOSE VOLUME BOX

Volume box is economic and convenience for bike shops to serve and replace hydraulic hose for customers.

Recommendation:
Page 82 - **HYDRAULIC HOSE CUTTER.**



SUPER SUPREME™ 5.5MM



Scratch Resistant Cover

Stainless Steel Mesh

CLEAR BLUE
HK-SSU030

SMOKE-BLACK
HK-SSU030SB

RED
HK-SSU030RD

BLUE
HK-SSU030BL

YELLOW
HK-SSU030YW

SUPREME™ 5.5MM



Scratch Resistant Cover

Stainless Steel Mesh

CLEAR BLUE
HK-SU030

ULTIMATE™ 5.5MM



Scratch Resistant Cover

BLACK
HK-UL030

WHITE
HK-UL030WH

RED
HK-SSU030RD

BLUE
HK-UL030BL

YELLOW
HK-UL030YW

GREEN
HK-UL030GN

PINK
HK-UL030PK

MAXXIS ORANGE
HK-UL030MO

ULTIMATE™ 5MM

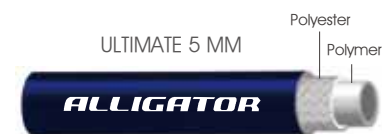

Scratch Resistant Cover

BLACK
HK-UL5030

WHITE
HK-UL5030WH

RED
HK-UL5030RD

BLUE
HK-UL5030BL

YELLOW
HK-UL5030YW

GREEN
HK-UL5030GN

PINK
HK-UL5030PK

MAXXIS ORANGE
HK-UL5030MO

HYDRAULIC HOSE FITTINGS
AND ACCESSORIES









HOSE FITTING DIY KIT









5MM HYDRAULIC SYSTEM

Some special disc brake calipers have no space for screw-type connector.

ITEM No.	DESCRIPTION	COMPATIBILITY
HK-HST51-DIY	 Straight Connector Set	Magura, Avid, Hayes
HK-HST52-DIY	 Banjo Set	Shimano, Magura, Avid, Hayes
HK-HST53-DIY	 Insert Set	Shimano
HK-HST54-DIY	 Insert Set	Magura
HK-HST55-DIY	 Insert Set	Avid
HK-HST56-DIY	 Insert Set	Formula
HK-HST57-DIY	 Insert Set	Hayes

5.5 MM HYDRAULIC SYSTEM

Some special disc brake calipers have no space for screw-type connector.

ITEM No.	DESCRIPTION	COMPATIBILITY
HK-HST01-DIY	 Straight Connector Set	Magura, Avid, Hayes
HK-HST02-DIY	 Banjo Set	Shimano, Magura, Avid, Hayes
HK-HST03-DIY	 Straight Connector Set	Shimano
HK-HST04-DIY	 Insert Set	Magura
HK-HST08-DIY	 Insert Set	Hayes El Camino Lever side/ Sole Lever & Caliper side
HK-HST05-DIY	 Rotor Torx screw & Wrench	For IS Rotor
HK-HST05Ti-DIY	 Rotor Torx Titanium screw & Wrench	For IS Rotor

WORKSHOP SERIES



ITEM NO.	DESCRIPTION					PACKAGE
HK-COM011	Replacement parts for original Magura, Shimano, Avid, Hayes and Formula hydraulic hoses.					1 Set/ Carrying Box
NUT COVER	FORMULA	HAYES	AVID	SHIMANO	MAGURA	
9 pcs HK-24	10 pcs HK-FM01	10 pcs HK-HY01	10 pcs HK-AV01	10 pcs HK-SH01	10 pcs HK-MG01	
9 pcs HK-24	10 pcs HK-FM02	10 pcs HK-HY02	10 pcs HK-AV02	10 pcs HK-SH02	10 pcs HK-MG02	
9 pcs HK-24	10 pcs HK-FM03	10 pcs HK-HY03	10 pcs HK-AV03	10 pcs HK-SH03	10 pcs HK-MG03	









ITEM NO.	DESCRIPTION					PACKAGE
HK-COM001	Replacement parts for Alligator 5.5mm hydraulic hoses.					Full Set/ Carrying Box
HK-COM002	The Same parts below, but half quantity.					Half Set/ Carrying Box
FULL						
10 pcs HK-10	20 pcs HK-15	25 pcs HK-18	100 pcs HK-21	12 pcs HK-26	10 pcs HK-49	
100 pcs HK-13	50 pcs HK-16	25 pcs HK-19	25 pcs HK-22-7	50 pcs HK-30		
50 pcs HK-14	25 pcs HK-17	50 pcs HK-20	20 pcs HK-23	10 pcs HK-40	1 pcs HK-CUT003	

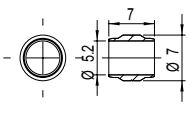

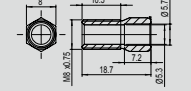

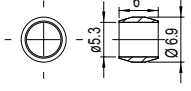
5 MM HYDRAULIC HOSE FITTINGS

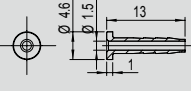



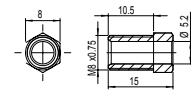

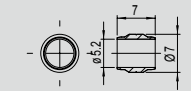
SHIMANO

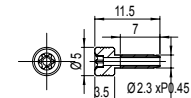
ITEM No.	DESCRIPTION	MATERIAL	Q'TY
HK-SH04#B50	  Compression nut for Shimano, 2011 XTR	Steel	50 Pcs/ Bottle
HK-SH01#B50	  Compression nut	Steel	50 Pcs/ Bottle
HK-SH02#B200	  Bushing for Shimano	Brass	200 Pcs/ Bottle
HK-SH03#B200	  Inserts for Shimano, Not include 2011 XTR	Brass	200 Pcs/ Bottle

AVID

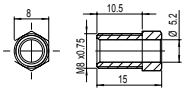
ITEM No.	DESCRIPTION	MATERIAL	Q'TY
HK-AV01#B50	  Compression nut for Avid Juicy, CODE, Elixir XX	Steel	50 Pcs/ Bottle
HK-AV02#B200	  Bushing for Avid Juicy, CODE, Elixir XX	Aluminum	200 Pcs/ Bottle
HK-AV03#B200	  Inserts for Avid Juicy, CODE, Elixir XX	Steel	200 Pcs/ Bottle

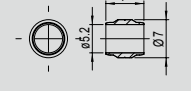
FORMULA

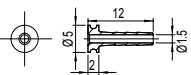
ITEM No.	DESCRIPTION	MATERIAL	Q'TY
HK-FM01#B50	  Compression nut for Formula R1, THE ONE, MEGA	Steel	50 Pcs/ Bottle
HK-FM02#B200	  Bushing for Formula R1, THE ONE, MEGA	Brass	200 Pcs/ Bottle
HK-FM03#200	  Inserts for Formula R1, THE ONE, MEGA	Steel	200 Pcs/ Bottle

HYDRAULIC HOSE FITTINGS AND ACCESSORIES

MAGURA

ITEM No.	DESCRIPTION	MATERIAL	Q'TY
HK-MG01#B50	Compression nut for Magura	Steel	50 Pcs/ Bottle
HK-MG02#B200	Bushing for Magura	Aluminum	200 Pcs/ Bottle
HK-MG03#B200	Inserts for Magura	Steel	200 Pcs/ Bottle

HAYES

ITEM No.	DESCRIPTION	MATERIAL	Q'TY
HK-HY01#B50	Compression nut for Hayes	Steel	50 Pcs/ Bottle
HK-HY02#B200	Bushing for Hayes	Brass	200 Pcs/ Bottle
HK-HY03#B200	Inserts for Hayes	Aluminum	200 Pcs/ Bottle

OTHER PARTS

ITEM No.	DESCRIPTION	MATERIAL	Q'TY
HK-17-1#B50	Banjo end For Shimano, Avid	Stainless	50 Pcs/ Bottle
HK-18-1#B50	Banjo nut For Shimano, Avid, Formula	Stainless	50 Pcs/ Bottle
HK-19#B50	Banjo bolt	Stainless	50 Pcs/ Bottle
HK-21#B200	O-ring For Shimano, Avid	Rubber	200 Pcs/ Bottle
HK-15-1#B30	Compression nut (Int.)	Stainless	30 Pcs/ Bottle
HK-23#B50	Compression nut (Ext.)	Stainless	50 Pcs/ Bottle
HK-24#B30	Plastic cap	Plastic	30 Pcs/ Bottle
HK-69#B50	Straight connector For Magura, Hayes	Stainless	50 Pcs/ Bottle

5.5 MM HYDRAULIC HOSE FITTINGS

ITEM No.			DESCRIPTION	MATERIAL	Q'TY
HK-13#B200			Bushing (S)	Brass	200 Pcs/ Bottle
HK-14#B200			Bushing (L)	Brass	200 Pcs/ Bottle
HK-16#B200			Inserts	Brass	200 Pcs/ Bottle
HK-49#B100			Inserts for HAYES Sole	Brass	100 Pcs/ Bottle
HK-15#B30			Compression nut (Int.)	Stainless	30 Pcs/ Bottle
HK-23#B50			Compression nut (Ext.)	Stainless	50 Pcs/ Bottle
HK-17#B50			Banjo end	Stainless	50 Pcs/ Bottle
HK-40#B40			Banjo end for EVOLUZIONE	Alloy	40 Pcs/ Bottle
HK-18#B50			Banjo nut	Stainless	50 Pcs/ Bottle
HK-19#B50			Banjo bolt	Stainless	50 Pcs/ Bottle
HK-19Ti#B50			Banjo Bolt	Titanium	50 Pcs/ Bottle
HK-20#B200			Alloy washer	Alloy	200 Pcs/ Bottle
HK-21#B200			O-ring	Rubber	200 Pcs/ Bottle
HK-22-7#B50			Straight connector for MAGURA, HAYES	Stainless	50 Pcs/ Bottle
HK-24#B30			Plastic cap	Plastic	30 Pcs/ Bottle
HK-25#B30			Rubber cap	Rubber	30 Pcs/ Bottle
HK-29#B200			Calipers shim	Alloy	200 Pcs/ Bottle
HK-30#B200			Calipers shim	Alloy	200 Pcs/ Bottle

5 MM HYDRAULIC HOSE FITTING INSTALLATION OPTIONS



Ax2 Kx2 Hx2
Suitable for Hayes Sole



Ax2 Ex2 Gx1
Suitable for Hayes HFX MAG Plus, HD, XC

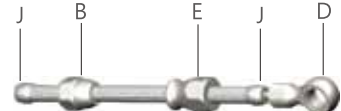

Jx2 Ex1 Dx1 Bx1
Suitable for Formula Evoluzione
Suitable for Hope and Giant MPH

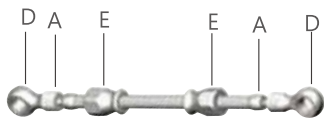

Ax2 Ex2 Dx2
Suitable for Shimano XTR (BR-M965, M966) Nexave (C-901) Deore XT 2002 / Formula B4, Oro, K18 / K24 4 Racing XC

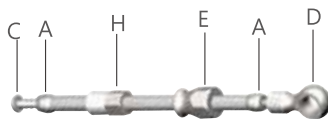

Ax2 Cx1 Ex1 Dx1 Hx1
Suitable for Shimano Saint (BR-M800), 4Piston (BR-M810), Deore XT (BR-M765-M755), Deore (BR-M555) / Magura Gustav M / Navigator, Gatorbrake / Clim8, Avid / Formula Mega, R1, The one

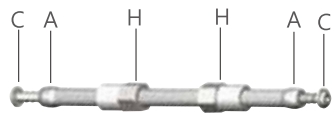

Ax2 Cx2 Hx2
Suitable for Shimano XTR (BR-M975, M975P) Hone (BR-M601), SLX (BR-M665), Deore XT (BR-M775) Deore LX (BR-M585), Deore (BR-M535, M525, M485), Alfine (BR-S500) / Canondale (Coda)

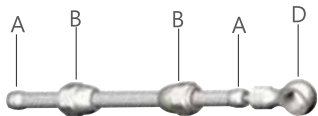

Ax2 Dx1 Bx2
Suitable for Hayes MAG

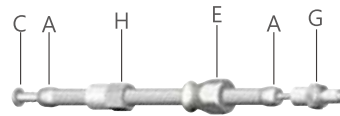

Ax2 Cx1 Ex1 Gx1 Hx1
Suitable for Magura Marta, SL, Magnesium SL, Louise, Carbon, Bat, Clara, Julie, Julie hp, HS33 / Hayes HFX9, Carbon, HD, XC

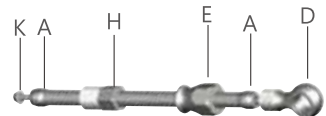

Ax2 Kx1 Hx1 Ex1 Dx1
Suitable for Hayes El Camino

HK-SH02
Bushing (S)

A



HK-15-1
Compression Nut (Int.)

B



HK-SH03
Inserts

C



HK-17-1
Banjo End (Stainless Steel)

D



HK-18-1
Banjo Nut

E



HK-19
Banjo Bolt

F



HK-69
Straight connector for Magura / Hayes

G



HK-23
Compression Nut (Ext.)

H



HK-14
BUSHING (L)

J



HK-HY02
Insert (Hayes Sole)

K





MOAI



- 2 Piece rotors with stainless-clad and aluminum-core.
- Better heat dissipation, not easy to deform.
- Stylish shape.
- More stabilized stopping power to prevent losing control when emergency braking.

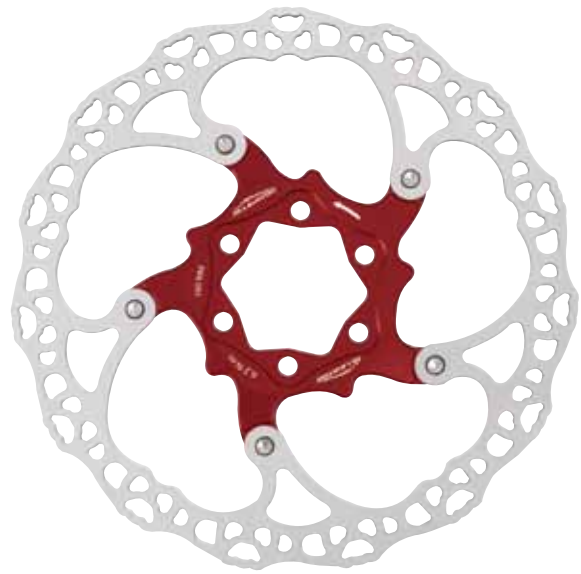
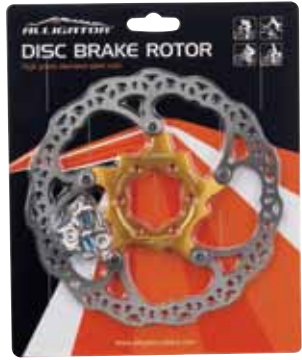

ITEM No.	MOAI	COLOR	SIZE	WEIGHT
HK-R34RD-DIY		Red (RD)	160mm	104g
HK-R34GD-DIY		Gold (GD)	160mm	104g
HK-R34BL-DIY		Blue (BL)	160mm	104g
HK-R34BK-DIY		Black (BK)	160mm	104g

MOTION

- High grade SUS 410 stainless steel rotor.
- Colorful and stylish.
- Titanium coated rotor provides superior surface hardness.

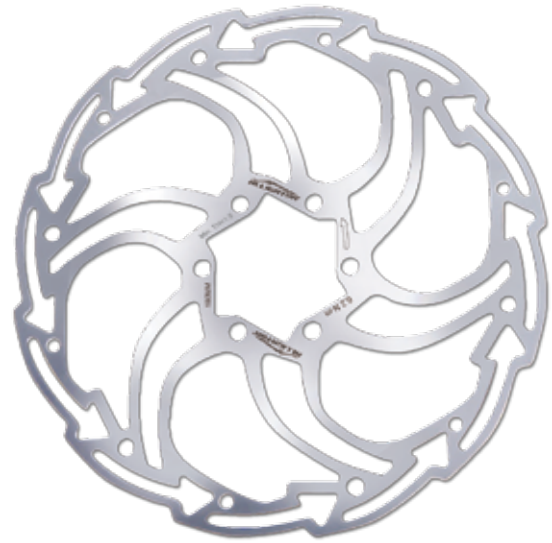

ITEM No.	MOTION	COLOR	SIZE	WEIGHT
HK-R24-DIY		Stainless Steel	160mm	101g
HK-R25-DIY			180mm	128g
HK-R26-DIY			203mm	158g
HK-R24Ti-DIY		Titanium Coated	160mm	101g
HK-R25Ti-DIY			180mm	128g
HK-R26Ti-DIY			203mm	158g
HK-R24WH-DIY		White (WH)	160mm	101g
HK-R25WH-DIY			180mm	128g
HK-R26WH-DIY			203mm	158g
HK-R24RD-DIY		Red (RD)	160mm	101g
HK-R25RD-DIY			180mm	128g
HK-R26RD-DIY			203mm	158g
HK-R24BL-DIY		Blue (BL)	160mm	101g
HK-R25BL-DIY			180mm	128g
HK-R26BL-DIY			203mm	158g
HK-R24BK-DIY		Black (BK)	160mm	101g
HK-R25BK-DIY			180mm	128g
HK-R26BK-DIY			203mm	158g

CROWN



- SUS 410 Stainless steel rotor.
- Titanium coated rotor provides superior surface hardness.
- Colorful and stylish.

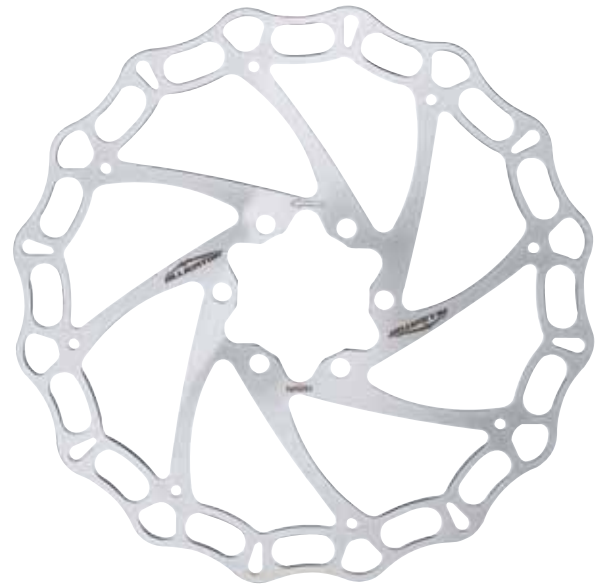

ITEM No.	CROWN	COLOR	SIZE	WEIGHT
HK-R27-DIY			160mm	84g
HK-R28-DIY		Stainless Steel	203mm	108g
HK-R29-DIY			180mm	142g
HK-R27Ti-DIY			160mm	84g
HK-R28Ti-DIY		Titanium Coated	180mm	108g
HK-R29Ti-DIY			203mm	142g
HK-R27WH-DIY			160mm	84g
HK-R28WH-DIY		White (WH)	180mm	108g
HK-R29WH-DIY			203mm	142g
HK-R27RD-DIY			160mm	84g
HK-R28RD-DIY		Red (RD)	180mm	108g
HK-R29RD-DIY			203mm	142g
HK-R27BL-DIY			160mm	84g
HK-R28BL-DIY		Blue (BL)	180mm	108g
HK-R29BL-DIY			203mm	142g
HK-R27BK-DIY			160mm	84g
HK-R28BK-DIY		Black (BK)	180mm	108g
HK-R29BK-DIY			203mm	142g

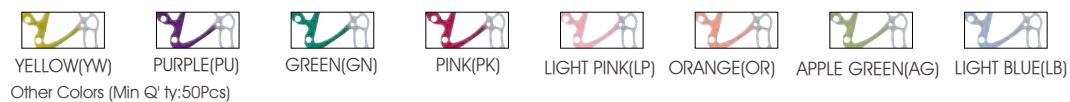

WIND-CUTTER™



- SUS 410 Stainless steel rotor.
- Titanium nitrite coated rotor provides superior surface hardness.
- Colorful and stylish.



ITEM No.	WIND-CUTTER™	COLOR	SIZE	WEIGHT
HK-R1 7-DIY		Stainless Steel	140mm	64g
HK-R1 11-DIY			160mm	92g
HK-R1 12-DIY			180mm	112g
HK-R1 13-DIY			203mm	154g
HK-R1 7Ti-DIY		Titanium Coated	140mm	62g
HK-R1 11Ti-DIY			160mm	95g
HK-R1 12Ti-DIY			180mm	115g
HK-R1 13Ti-DIY			203mm	154g
HK-R1 7WH-DIY		White (WH)	140mm	64g
HK-R1 11WH-DIY			160mm	92g
HK-R1 12WH-DIY			180mm	112g
HK-R1 13WH-DIY			203mm	154g
HK-R1 7RD-DIY		Red (RD)	140mm	64g
HK-R1 11RD-DIY			160mm	92g
HK-R1 12RD-DIY			180mm	112g
HK-R1 13RD-DIY			203mm	154g
HK-R1 7BL-DIY		Blue (BL)	140mm	64g
HK-R1 11BL-DIY			160mm	92g
HK-R1 12BL-DIY			180mm	112g
HK-R1 13BL-DIY			203mm	154g
HK-R1 7BK-DIY		Black (BK)	140mm	64g
HK-R1 11BK-DIY			160mm	92g
HK-R1 12BK-DIY			180mm	112g
HK-R1 13BK-DIY			203mm	154g



YELLOW(YW)



PURPLE(PU)



GREEN(GN)



PINK(PK)



LIGHT PINK(LP)



ORANGE(OR)



APPLE GREEN(AG)



LIGHT BLUE(LB)

Other Colors (Min Q'ty: 50Pcs)

iWAVE™



- SUS 410 Stainless steel rotor.
- Titanium coated rotor provides superior surface hardness.
- Colorful and stylish.

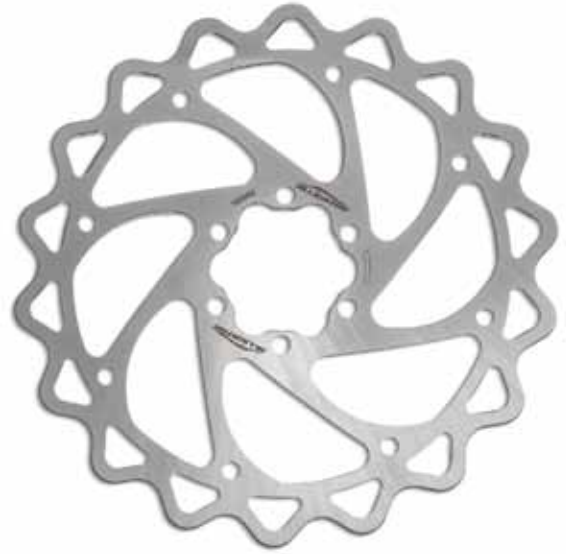

ITEM No.	iWAVE™	COLOR	SIZE	WEIGHT
HK-R14-DIY		Stainless Steel	160mm	107g
HK-R15-DIY			180mm	116g
HK-R16-DIY			203mm	152g
HK-R14Ti-DIY		Titanium Coated	160mm	107g
HK-R15Ti-DIY			180mm	116g
HK-R16Ti-DIY			203mm	155g
HK-R14WH-DIY		White (WH)	160mm	107g
HK-R15WH-DIY			180mm	116g
HK-R16WH-DIY			203mm	152g
HK-R14RD-DIY		Red (RD)	160mm	107g
HK-R15RD-DIY			180mm	116g
HK-R16RD-DIY			203mm	152g
HK-R14BL-DIY		Blue (BL)	160mm	107g
HK-R15BL-DIY			180mm	116g
HK-R16BL-DIY			203mm	152g
HK-R14BK-DIY		Black (BK)	160mm	107g
HK-R15BK-DIY			180mm	116g
HK-R16BK-DIY			203mm	152g



YELLOW(YW)



PURPLE(PU)



GREEN(GN)



PINK(PK)



LIGHT PINK(LP)



ORANGE(OR)



APPLE GREEN(AG)



LIGHT BLUE(LB)

Other Colors (Min Q'ty: 50Pcs)

STARLITE™



- SUS 410 Stainless steel rotor.
- Titanium coated rotor provides superior surface hardness.
- Colorful and stylish.

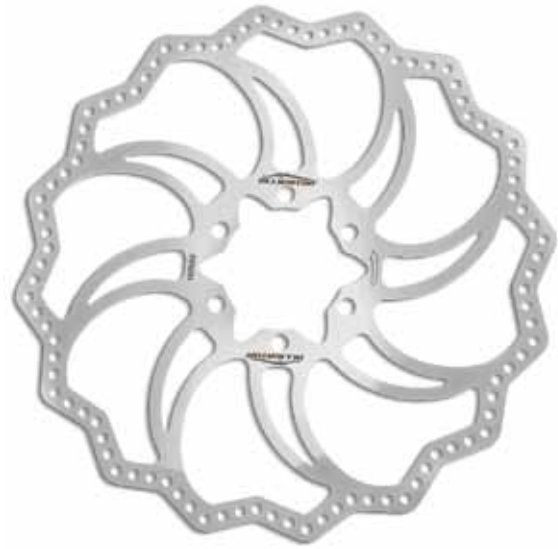

ITEM No.	STARLITE™	COLOR	SIZE	WEIGHT
HK-R18-DIY		Stainless Steel	160mm	90g
HK-R19-DIY			180mm	120g
HK-R20-DIY			203mm	130g
HK-R18Ti-DIY		Titanium Coated	160mm	90g
HK-R19Ti-DIY			180mm	102g
HK-R20Ti-DIY			203mm	130g
HK-R18WH-DIY		White (WH)	160mm	90g
HK-R19WH-DIY			180mm	120g
HK-R20WH-DIY			203mm	130g
HK-R18RD-DIY		Red (RD)	160mm	90g
HK-R19RD-DIY			180mm	120g
HK-R20RD-DIY			203mm	130g
HK-R18BL-DIY		Blue (BL)	160mm	90g
HK-R19BL-DIY			180mm	120g
HK-R20BL-DIY			203mm	130g
HK-R18BK-DIY		Black (BK)	160mm	90g
HK-R19BK-DIY			180mm	120g
HK-R20BK-DIY			203mm	130g



ARIES™



- SUS 410 Stainless steel rotor.
- Titanium coated rotor provides superior surface hardness.
- Colorful and stylish.

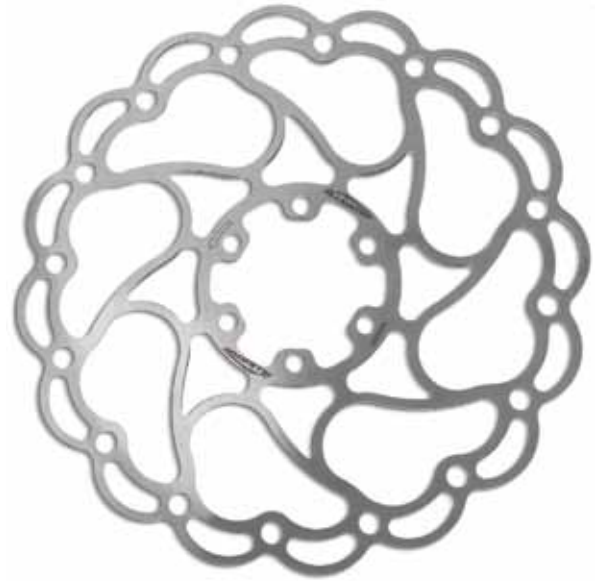

ITEM No.	ARIES™	COLOR	SIZE	WEIGHT
HK-R21-DIY		Stainless Steel	160mm	80g
HK-R22-DIY			180mm	100g
HK-R23-DIY			203mm	127g
HK-R21Ti-DIY		Titanium Coated	160mm	80g
HK-R22Ti-DIY			180mm	100g
HK-R23Ti-DIY			203mm	127g
HK-R21WH-DIY		White (WH)	160mm	80g
HK-R22WH-DIY			180mm	100g
HK-R23WH-DIY			203mm	127g
HK-R21RD-DIY		Red (RD)	160mm	80g
HK-R22RD-DIY			180mm	100g
HK-R23RD-DIY			203mm	127g
HK-R21BL-DIY		Blue (BL)	160mm	80g
HK-R22BL-DIY			180mm	100g
HK-R23BL-DIY			203mm	127g
HK-R21BK-DIY		Black (BK)	160mm	80g
HK-R22BK-DIY			180mm	100g
HK-R23BK-DIY			203mm	127g



ALLIGATOR



- ALLIGATOR Original rotor.
- High grade SUS 410 stainless steel rotor.
- Stylish.

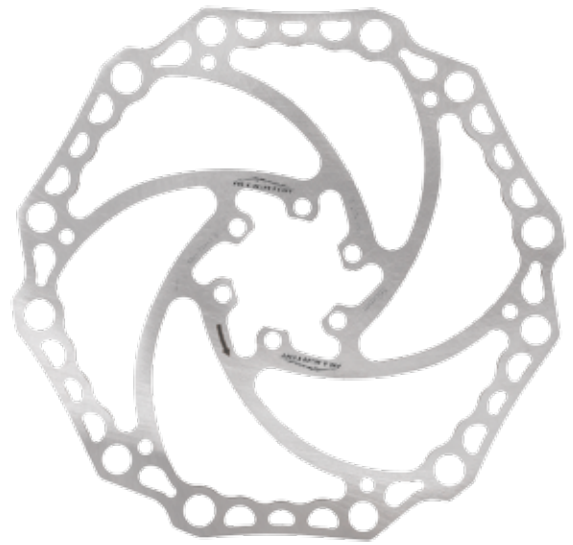

ITEM No.	ALLIGATOR	COLOR	SIZE	WEIGHT
HK-R43-DIY		Stainless Steel	140mm	72g
HK-R44-DIY			160mm	90g
HK-R45-DIY			180mm	114g
HK-R43RD-DIY		Red (RD)	140mm	72g
HK-R44RD-DIY			160mm	90g
HK-R45RD-DIY			180mm	114g
HK-R43BK-DIY		Black (BK)	140mm	72g
HK-R44BK-DIY			160mm	90g
HK-R45BK-DIY			180mm	114g

STEALTH



- Light weight design.
- Over 30% lighter than other rotors.
- High grade SUS 410 stainless steel rotor.



ITEM No.	STEALTH	COLOR	SIZE	WEIGHT
HK-R49-DIY		Stainless Steel	140mm	56g
HK-R50-DIY			160mm	70g
HK-R48-DIY			180mm	82g

PIZZA

ITEM No.	COLOR	SIZE	WEIGHT
HK-R77-DIY	Stainless Steel	120mm	86g
HK-R01-DIY		160mm	117g
HK-R02-DIY		180mm	134g
HK-R03-DIY		203mm	188g



CLASSIC

ITEM No.	COLOR	SIZE	WEIGHT
HK-R04-DIY	Stainless Steel	150mm	78g
HK-R05-DIY		170mm	116g

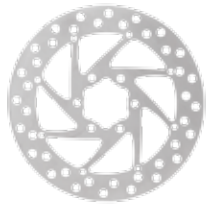

ALIEN

ITEM No.	COLOR	SIZE	WEIGHT
HK-R07-DIY	Stainless Steel	203mm	140g

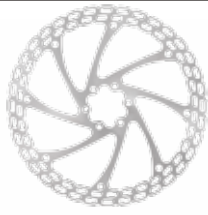



DIY Card with screws.









IS TO POST MOUNT

ITEM NO.	CNC MODEL	ITEM NO.	FORGED MODEL	CONVERSION FROM	CALIPER CONVERSION TO
HK-XQ01-DIY		HK-XQ23-DIY		Front Fork IS 160 mm	Front Post mount 203 mm
				Frame Rear IS 180 mm	Frame Rear Post mount 180 mm
HK-XQ04-DIY		HK-XQ32-DIY		Frame Rear IS 203 mm	Frame Rear Post Mount 203 mm
HK-XQ05-DIY		HK-XQ22-DIY		Front Fork IS 180 mm	Front Fork Post mount 180 mm
				Frame Rear IS 160 mm	Frame Rear Post mount 160 mm
HK-XQ06-DIY		HK-XQ31-DIY		Front Fork IS 160 mm	Front Fork Post mount 160 mm
				Frame Rear IS 140 mm	Frame Rear Post mount 140 mm
HK-DAD602FBK-DIY				Front Fork IS 150 mm	Front Fork Post mount 203 mm

POST MOUNT TO IS

ITEM NO.	FORGED MODEL	CONVERSION FROM	CALIPER CONVERSION TO
HK-XQ34-DIY		Frame Rear Post mount 180 mm	Frame Rear IS 180 mm
HK-XQ35-DIY		Frame Rear Post mount 160 mm	Frame Rear IS 160 mm
HK-XQ36-DIY		Front Fork Post mount 180 mm	Front Fork IS 180 mm

SIZE CONVERSION

ITEM NO.	CNC MODEL	ITEM NO.	FORGED MODEL	CONVERSION FROM	CALIPER CONVERSION TO
HK-XQ02-DIY		HK-XQ21-DIY		Front Fork Post mount 160 mm	Front Fork Post mount 180 mm
HK-XQ03-DIY		HK-XQ33-DIY		Front Fork Post mount 160 mm	Front Fork Post Mount 203 mm
HK-DAD801FLGD-DIY				Front Fork IS 160 mm	Front Fork IS 203 mm
HK-DAD801RGD-DIY				Frame Rear IS 160 mm	Frame Rear IS 203 mm
HK-DAD801FRGD-DIY				Front Fork IS Right 160 mm	Front Fork IS Right 203 mm
HK-DAD801RBK-DIY				Frame Rear IS 160 mm	Frame Rear IS 203 mm
HK-DAD601FRBK-DIY				Front Fork IS Right 150 mm	Front Fork IS Right 203 mm
HK-DAD604RBK-DIY				Frame Rear IS 170 mm	Frame Rear IS 203 mm
HK-DAD604FBK-DIY				Front Fork IS 150 mm	Front Fork IS 203 mm
HK-DAD605FBK-DIY				Front Fork IS Heavy 150 mm	Front Fork IS 203 mm

CENTER-LOCK ADAPTER

- For Shimano hub & IS 6-hole rotors only.
- Don't need any screw to lock rotors.
- All center-lock adjusters are made by CNC machined aluminum.

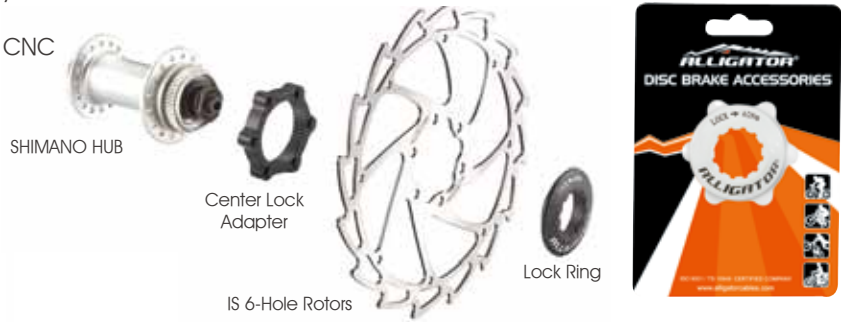

All center-lock adjusters are made by CNC Machined Aluminum.

ITEM NO.	LOCK RING	CENTER-LOCK ADAPTER	DESCRIPTION	COLOR
HK-CLA01-AS-DIY			For 9mm Shimano hub	Black
HK-CLA01-GD-AS-DIY			For 9mm Shimano hub	Gold
HK-CLA01-RD-AS-DIY			For 9mm Shimano hub	Red
HK-CLA01-WH-AS-DIY			For 9mm Shimano hub	White
HK-CLA01-BL-AS-DIY			For 9mm Shimano hub	Blue
HK-CLA02-AS-DIY			For 15 & 20 mm thru-axle hub	Black
HK-CLA02-GD-AS-DIY			For 15 & 20 mm thru-axle hub	Gold
HK-CLA02-RD-AS-DIY			For 15 & 20 mm thru-axle hub	Red
HK-CLA02-WH-AS-DIY			For 15 & 20 mm thru-axle hub	White
HK-CLA02-BL-AS-DIY			For 15 & 20 mm thru-axle hub	Blue

FREEWHEEL COVER

Please contact with ALLIGATOR if you need other size.

ITEM NO.	DESCRIPTION	COLOR
HK-FC01-MB-DIY		Black
HK-FC01-RD-DIY	For 12T	Red
HK-FC01-GD-DIY		Gold

MECHANICAL DISC BRAKE SYSTEM

LY-M170 Whole set includes CLIPPER, LEVER, ROTOR and accessories.

- Melt forged aluminum ball bearing mechanical disc brake
- Light weight design
- High performance resin compound pads compatible with Hayes sole type.
- Easy replacement.



LY-M170



LEVER(OPTIONAL)



COOL YOUR BRAKE, COOL YOUR MIND

COOL SERIES DISC BRAKE PADS

- Reliable Organic Compound pads with Multiple alloy heat-sink pillars
- Help heat dissipate quickly
- 20% cooler than normal cool pads.

DIY brake pads set includes spring and ping if necessary.

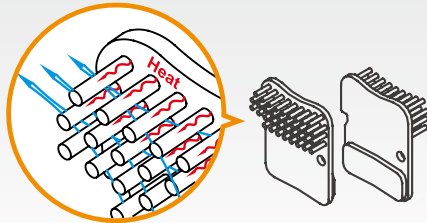

SHIMANO

ITEM NO.	COMPATIBILITY
HK-COOL018-DIY+ 	XTR BR-M965, BR-M966, BR-M975/ Saint BR-M800/ Deore XT BR-M765, BR-M775, BR-R505
HK-COOL055-DIY+ 	XTR BR-M985/ Deore XT BR-785/ SLX BR-M166/ Alfine BR-S700
HK-COOL035-DIY+ 	Saint BR-M820/ Zee BR-M640

AVID

ITEM NO.	COMPATIBILITY
HK-COOL036-DIY+ 	AVID Elixir

FORMULA

ITEM NO.	COMPATIBILITY
HK-COOL034-DIY+ 	MEGA/ The one FR/The one/ R1/ RX

MAGURA

ITEM NO.	COMPATIBILITY
HK-COOL041-DIY 	MT2 / MT4 / MT6 / MT8

EXTREME CARBON BRAKE PADS



EXTREME DISC BRAKE PADS

- Contains a HIGH % of carbon fiber.
- No need to worry about unstable braking force caused by pad's heat exhaustion.
- Suitable for HIGH temperature environment, or extreme sport racers.

DIY brake pads set includes spring and ping if necessary.



SHIMANO

ITEM NO.			COMPATIBILITY
HK-EX008-DIY+			Deore BR-M525, BR-M515, BR-M515A/ Nexave BR-C501, BR-C601/ BR-M375/ BR-M415/ BR-M416/ BR-M416A/ BR-M446/ BR-M465/ BR-M475/ BR-M485/ BR-M486/ BR-M495/ BR-M495/ BR-M575/ BR-M395
HK-EX018-DIY+			XTR BR-M965, BR-966, BR-975, BR-975P/ Saint BR-M800/ Hone BR-M601/ SLX BR- M665/ LX BR-M585, BR-T665/ Deore XT BR- M776, BR-M775, BR-M765/ Deore BR-M535, BR-M595/ BR-M596/ Alfine BR-S500, BR- S501, BR-R505/ M545/ T605
HK-EX055-DIY+			XTR BR-M985/ Deore XT BR-785/ SLX BR-M666/ Alfine BR-S700

AVID

ITEM NO.			COMPATIBILITY
HK-EX012-DIY+			Juicy Carbon/ Juicy 3, 5, 7, BB7 Mech.
HK-EX036-DIY+			Avid Elixir/ SRAM XX

MAGURA

ITEM NO.			COMPATIBILITY
HK-EX041-DIY			MT-2, MT-4, MT-6, MT-8

HAYES

ITEM NO.			COMPATIBILITY
HK-EX033-DIY			Stroker Ryde

FORMULA

ITEM NO.			COMPATIBILITY
HK-EX022-DIY+			Oro/ K18/ K24
HK-EX034-DIY+			Mega/ The One FR/ The one/ R1/ RX

RST

ITEM NO.			COMPATIBILITY
HK-EX008-DIY+			D-POWER Mech.

DISC BRAKE PADS



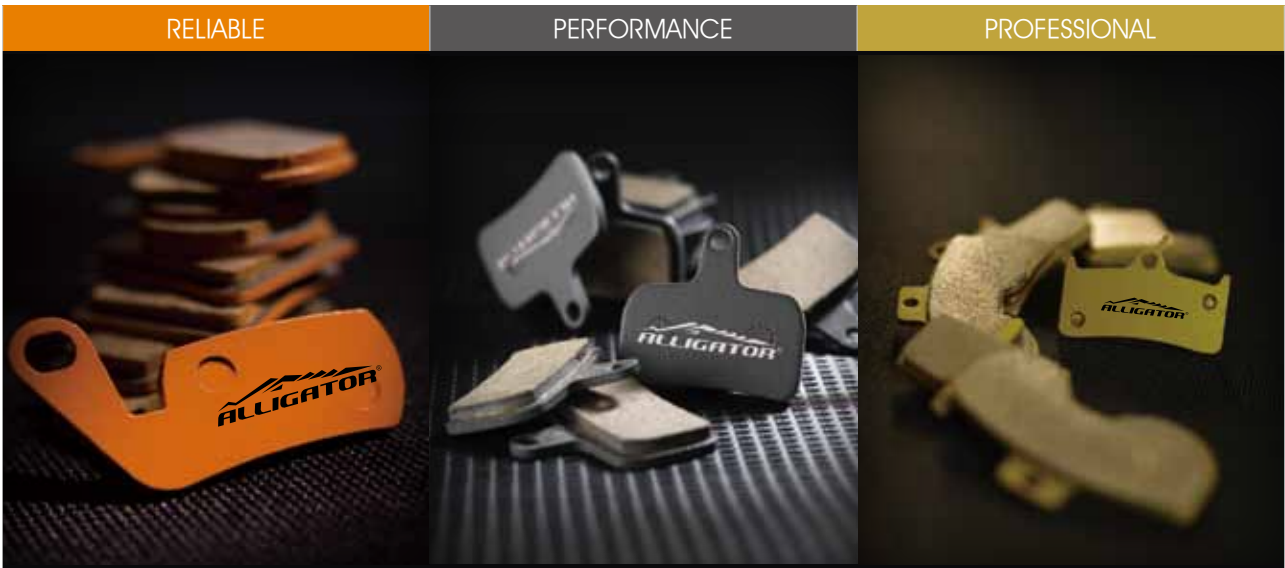

- ORGANIC COMPOUND PADS
- HIGH STATIC FRICTION COEFFICIENT
- SUPER BRAKING PERFORMANCE FOR BOTH DRY AND WET
- ALL WEATHER APPLICATION
- ASBESTOS FREE

- SEMI-METALLIC DUAL COMPOUND
- EXCELLENT BRAKING PERFORMANCE FOR BOTH DRY AND WET.
- DOUBLE THE PADS LIFE COMPARED TO ORGANIC PADS
- ALL WEATHER APPLICATION
- ASBESTOS FREE

- CERAMIC SINTERED
- Excellent braking performance in excess of 650oC
- TRIPLE THE PADS LIFE COMPARED WITH ORGANIC PADS.
- HIGH STATIC FRICTION COEFFICIENT
- ALL WEATHER APPLICATION



DIY brake pads set includes spring and ping if necessary.

FORMULA

RELIABLE	PERFORMANCE	PROFESSIONAL		COMPATIBILITY
HK-VX017-DIY+	HK-BP017-DIY+	HK-CSP17-DIY+		B4/ Racing XC/ Extreme FR/ Pro/ SL
HK-VX022-DIY+	HK-BP022-DIY+	HK-CSP22-DIY+		ORO/ K18/ K24
HK-VX034-DIY+	HK-BP034-DIY+	HK-CSP34-DIY+		Mega/ The one/ R1/ RO/ RX/ T1/ R1 Racing/ RR1

AVID

RELIABLE	PERFORMANCE	PROFESSIONAL		COMPATIBILITY
HK-VX006-DIY+	HK-BP006-DIY+	HK-CSP06-DIY+		Sram® mech. 9.0
HK-VX012-DIY+	HK-BP012-DIY+	HK-CSP12-DIY+		Juicy 3, 5, 7/ Carbon/BB7 Mech.
HK-VX027-DIY+	HK-BP027-DIY+	HK-CSP27-DIY+		BB5 Mech.
HK-VX029-DIY+	HK-BP029-DIY+	HK-CSP29-DIY+		Code/ Code 5
HK-VX036-DIY+	HK-BP036-DIY+	HK-CSP36-DIY+		Elixir/ Sram XX
HK-VX042-DIY+	HK-BP042-DIY+	HK-CSP42-DIY+		Code R
HK-VX057-DIY+	HK-BP057-DIY+	HK-CSP57-DIY+		Avid XO Trail/ 7 Trial/ 9 Trial/ Sram

TEKTRO

RELIABLE	PERFORMANCE	PROFESSIONAL		COMPATIBILITY
HK-VX008-DIY+	HK-BP008-DIY+	HK-CSP08-DIY+		Aquila/ Auriga PRO/ Auriga E/ Comp/ Draco 2/ Dorado/ Draco WS/ Draco 2 Gemini/ HD-M330
HK-VX038-DIY	HK-BP038-DIY	HK-CSP38-DIY		IO/ IOX
HK-VX039-DIY	HK-BP039-DIY	HK-CSP39-DIY		Novela/ IOX/ Lyra

SHIMANO

RELIABLE

PERFORMANCE

PROFESSIONAL

COMPATIBILITY

HK-VX006-DIY+ HK-BP006-DIY+ HK-CSP06-DIY+



Deore XT BR-M755/Grimeca system 8/ Sram® mech. 9.0, Cleg DH

HK-VX007-DIY+ HK-BP007-DIY+ HK-CSP07-DIY+



Deore BR-M555, BR-M555-M, BR-M556/ Nexave BR-C900, BR-C901

HK-VX008-DIY+ HK-BP008-DIY+ HK-CSP08-DIY+



Deore BR-M515, BR-515M, BR-M525, BR-M575/ Nexave BR-C501, BR-C601/ Acera BR-M415, BR-M416, BR-M416A, BR-M446/ Alivio BR-M465, BR-M475, BR-M485, BR-M486, BR-M495/ BR-M375 MECH/ RST D-POWER MECH/

HK-VX018-DIY+ HK-BP018-DIY+ HK-CSP18-DIY+



XTR BR-M965, BR-966, BR-975, BR-975P/ Saint BR-M800/ Hone BR-M601/ SLX BR-M665/ LX BR-M585, BR-T665/ Deore XT BR-M776, BR-M775, BR-M765/ Deore BR-M535, BR-M595/ BR-M596/ Alfine BR-S500, BR-S501, BR-R505/ M545/ T605

HK-VX035-DIY+ HK-BP035-DIY+ HK-CSP35-DIY+



Saint BR-M810

HK-VX055-DIY+ HK-BP055-DIY+ HK-CSP55-DIY+





XTR 2011, BR-M985, BR-M988/ Deore XT BR-M785/ SLX BR-M666/ Alfine BR-S700

HOPE

RELIABLE	PERFORMANCE	PROFESSIONAL		COMPATIBILITY
-	HK-BP006-DIY+	HK-CSP06-DIY+		Mono M4
-	HK-BP009-DIY+	HK-CSP09-DIY+		Tech. C2
HK-VX015-DIY+	HK-BP015-DIY+	HK-CSP15-DIY+		XC-4 4 Pots
HK-VX019-DIY+	HK-BP019-DIY+	HK-CSP19-DIY+		2 Pots Mini
HK-VX020-DIY+	HK-BP020-DIY+	HK-CSP20-DIY+		M4 (2 pairs)
HK-VX024-DIY+	HK-BP024-DIY+	HK-CSP24-DIY+		Mono 6Ti
HK-VX025-DIY+	HK-BP025-DIY+	HK-CSP25-DIY+		Mono Mini
HK-VX030-DIY+	HK-BP030-DIY+	HK-CSP30-DIY+		Mono V2
HK-VX031-DIY	HK-BP031-DIY	HK-CSP31-DIY		Mono Trial
HK-VX040-DIY+	HK-BP040-DIY+	HK-CSP40-DIY+		Mono X2

HAYES

RELIABLE	PERFORMANCE	PROFESSIONAL		COMPATIBILITY
HK-VX010-DIY+	HK-BP010-DIY+	HK-CSP10-DIY+		HFX-Mag/ HFX-9 Hyd./ MX-1 Mech./ Promax/ Imperial DX04 Hyd.
HK-VX023-DIY	HK-BP023-DIY	-		GX-2/ MX-2/ MX-3/ MX-4/ Mech. / Sole/ Promax DSK-810
HK-VX026-DIY+	HK-BP026-DIY+	HK-CSP26-DIY+		El Camino
HK-VX032-DIY+	HK-BP032-DIY+	HK-CSP32-DIY+		Stroker Trail, Carbon, Gram
HK-VX033-DIY	HK-BP033-DIY	HK-CSP33-DIY		Stroker Ryde
HK-VX037-DIY+	HK-BP037-DIY+	HK-CSP37-DIY+		Stroker Ace
HK-VX056-DIY+	HK-BP056-DIY+	HK-CSP56-DIY+		Prime Expert, Prime Pro

GIANT

RELIABLE	PERFORMANCE	PROFESSIONAL		COMPATIBILITY
-	HK-BP009-DIY+	HK-CSP09-DIY+		MPH 2000
-	HK-BP021-DIY	-		Giant MPH 2001-2005 Min Q'ty: 250 Pairs

MAGURA

RELIABLE	PERFORMANCE	PROFESSIONAL		COMPATIBILITY
----------	-------------	--------------	--	---------------

HK-VX001-DIY	HK-BP001-DIY	HK-CSP01-DIY		Louise 1999-2001/ Clara 2000; Imperial mechanical caliper
HK-VX002-DIY+	HK-BP002-DIY+	HK-CSP02-DIY+		Louise FR/ Louise 2002-2006/Clara 2001-2002
HK-VX003-DIY+	HK-BP003-DIY+	HK-CSP03-DIY+		Julie 2001-2008
HK-VX004-DIY+	HK-BP004-DIY+	HK-CSP04-DIY+		Gustav M
HK-VX016-DIY	HK-BP016-DIY	HK-CSP16-DIY		Marta 2002-2008 /Marta SL
HK-VX028-DIY	HK-BP028-DIY	HK-CSP28-DIY		Louise 2007~ / Marta 2009~ / Julie HP/ Marta SL Magnesium
HK-VX041-DIY	HK-BP041-DIY	HK-CSP41-DIY		Magura MT2, MT4, MT6, MT8



ROAD BIKE BRAKE SHOES

- Anodized and CNC machined or Sand Blast aluminum holder.
- Cartridge type brake block. Suitable for Alloy rims.
- All-weather available.



PROFESSIONAL ROAD BIKE BRAKE SHOES

ITEM NO.	DESCRIPTION	COMPATIBILITY	WEIGHT	COLOR
RD-303-WG-DIY	 CNC Machined Road Professional	Shimano 55 mm	36 g	Black/ White & Gold
RD-303-BG-DIY	 CNC Machined Road Professional	Shimano 55 mm	36 g	Black/ Black & Gold
RD-303-PB-DIY	 CNC Machined Road Professional	Shimano 55 mm	36 g	Black/ Pink & Blue
RD-302-DIY	 Sand Blast Lightweight Road Professional	Shimano 55 mm	34 g	Black/ Silver
RD-302-1-DIY	 Sand Blast Lightweight Road Professional	Shimano 55 mm	34 g	Black/ Black
RD-302-RD-DIY	 Sand Blast Lightweight Road Professional	Shimano 55 mm	34 g	Triple/ Red
RD-302-GD-DIY	 Sand Blast Lightweight Road Professional	Shimano 55 mm	34 g	Triple/ Gold
RD-302-GR-DIY	 Sand Blast Lightweight Road Professional	Shimano 55 mm	34 g	Triple/ Green
RD-302-BL-DIY	 Sand Blast Lightweight Road Professional	Shimano 55 mm	34 g	Triple/ Blue
RD-300-CA-DIY	 Full Carbon holder Road Professional	Shimano 55 mm	30 g	Black/ Carbon

PERFORMANCE ROAD BIKE BRAKE SHOES











- High performance brake shoes.
- Anodized aluminum holder.
- All-weather available.





ITEM NO.		DESCRIPTION	COMPATIBILITY	WEIGHT	COLOR
RD-300-DIY		Road Performance	Shimano 55mm	40 g	Black/ Silver
RD-300Ti-DIY		Titanium Look Road Performance	Shimano 55mm	40 g	Black/ Titanium
RD-300-1-DIY		Road Performance	Shimano 55mm	40 g	Green/ Silver
RD-300-2-DIY		Road Performance	Shimano 55mm	40 g	Grey/ Silver
RD-300-3-DIY		Carbon Look Road Performance	Shimano 55mm	42 g	Black/ Carbon
RD-300-4-DIY		Road Performance	Shimano 55mm	40 g	Black/ Black
RD-300i-DIY		Brake Block Replacement	For Alloy rims 55 mm	14 g	Black
RD-300ic-DIY		Brake Block Replacement	For Ceramic rims 55 mm	14 g	Green
RD-300ica-DIY		Brake Block Replacement	For Carbon rims 55 mm	10 g	Brown
RD-300i-BL-DIY		Brake Block Replacement	55 mm	12 g	Blue
RD-300i-GY-DIY		Brake Block Replacement	55 mm	12 g	Grey
RD-300i-CF-DIY		Brake Block Replacement	55 mm	12 g	Brown

ITEM NO.		DESCRIPTION	COMPATIBILITY	WEIGHT	COLOR
RD-350-CF-DIY		Suitable for Triathlon & Time trial bike Road Performance	55 mm	34 g	Brown/ Black
RD-350-3C-DIY		Suitable for Triathlon & Time trial bike Road Performance	55 mm	34 g	Triple/ Black
RD-350-BK-DIY		Suitable for Triathlon & Time trial bike Road Performance	55 mm	34 g	Black/ Black
RD-304-DIY		Sand Blast Road Performance	55 mm	34 g	Triple/ Silver
RD-304-RD-DIY		Sand Blast Road Performance	55 mm	34 g	Triple/ Red
RD-304-BL-DIY		Sand Blast Road Performance	55 mm	34 g	Triple/ Blue
RD-304-BK-DIY		Sand Blast Road Performance	55 mm	34 g	Triple/ Black
RD-304-GD-DIY		Sand Blast Road Performance	55 mm	34 g	Triple/ Gold
RD-304-GN-DIY		Sand Blast Road Performance	55 mm	34 g	Triple/ Green

RELIABLE ROAD BIKE BRAKE SHOES

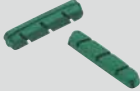
- Stable and Reliable brake shoes for road bike.
- All-weather available.

ITEM NO.		DESCRIPTION	COMPATIBILITY	WEIGHT	COLOR
RD-300-RD-DIY		Road Reliable	Shimano 55mm	40 g	Triple/ Red
RD-300-OR-DIY		Road Reliable	Shimano 55mm	40 g	Triple/ Orange
RD-300-WH-DIY		Road Reliable	Shimano 55mm	40 g	Triple/ White
RD-300-LG-DIY		Road Reliable	Shimano 55mm	40 g	Triple/ Green
RD-300-PK-DIY		Road Reliable	Shimano 55mm	40 g	Triple/ Pink
RD-300-BL-DIY		Road Reliable	Shimano 55mm	40 g	Triple/ Blue
RD-300-i3-DIY		Brake Block Replacement	Shimano 55mm	12 g	Triple
RD-300-iw-DIY		Brake Block Replacement	Shimano 55mm	15 g	White
RD-500-DIY		Road Reliable	Campagnolo 53 mm	40 g	Black/ Silver
RD-500-B-DIY		Road Reliable	Campagnolo 53 mm	40 g	Black/ Black

ITEM NO.		DESCRIPTION	COMPATIBILITY	WEIGHT	COLOR
RD-500i-DIY		Brake Block Replacement	Campagnolo 53 mm	12 g	Black
RD-500ic-DIY		Brake Block Replacement	Campagnolo 53 mm	12 g	Green
RD-500ica-DIY		For Carbon Rim Brake Block Replacement	Campagnolo 53 mm	12 g	Brown
RD-320-DIY		Road Reliable	50 mm	52 g	Black
RD-321-DIY		Road Reliable	50 mm	48 g	Black
RD-322-DIY		Road Reliable	50 mm	40 g	Black

CALIPER BRAKE SHOES

ITEM NO.		DESCRIPTION	COMPATIBILITY	WEIGHT	COLOR
CA-350-DIY		Caliper Brake Shoes.	For alloy rims, 40mm	46 g	Black/ Silver
CA-351-DIY		Caliper Brake Shoes.	For alloy rims, 40mm	46 g	Black/ Silver
CA-351-2-DIY		Caliper Brake Shoes.	For alloy rims, 40mm	46 g	Grey/ Silver
CA-351-1-DIY		Caliper Brake Shoes.	For alloy rims, 35mm	40 g	Black
CA-351-3-DIY		Caliper Brake Shoes.	For alloy rims, 35mm	40 g	Grey

MOUNTAIN BIKE BRAKE SHOES



PROFESSIONAL MTB BRAKE SHOES

- Anodized and CNC aluminum threaded type holder.
- Cartridge type brake block. Suitable for V-Brake, Alloy rims.
- All-weather available.

ITEM NO.		DESCRIPTION	COMPATIBILITY	WEIGHT	COLOR
VB-689-DIY		New Groove design Black & Red brake block Light weight	72mm	54 g	Black
VB-688-DIY		Light weight Triple color brake block	72mm	54 g	Silver
VB-688-RD-DIY		Light weight Triple color brake block	72mm	54 g	Red
VB-688-GD-DIY		Light weight Triple color brake block	72mm	54 g	Gold
VB-688-BL-DIY		Light weight Triple color brake block	72mm	54 g	Blue
VB-687-DIY		Light weight	72mm	54 g	Silver
VB-686-BB-DIY		MTB Professional	72mm	50 g	Black & Blue
VB-686-BG-DIY		MTB Professional	72mm	50 g	Black & Gold
VB-686-WG-DIY		MTB Professional	72mm	50 g	White & Gold

PERFORMANCE MTB BRAKE SHOES

- Anodized aluminum threaded type holder.
- Cartridge type brake block. Suitable for V-Brake, Alloy rims.
- All-weather available.







ITEM NO.	DESCRIPTION	COMPATIBILITY	WEIGHT	COLOR
VB-600-DIY	 MTB Performance	72 mm	56 g	Black/ Silver
VB-600-BK-DIY	 MTB Performance	72 mm	56 g	Black/ Black
VB-600Ti-DIY	 Titanium look MTB Performance	72 mm	56 g	Black/ Titanium
VB-600-CA-DIY	 Carbon look MTB Performance	72 mm	58 g	Black/ Carbon
VB-660-DIY	 MTB Performance	72 mm	56 g	Triple/ Silver
VB-660-BK-DIY	 MTB Performance	72 mm	56 g	Triple/ Black
VB-660i-DIY	 Brake Block Replacement	72 mm	14 g	Triple
VB-660i-RD-DIY	 Brake Block Replacement	72 mm	14 g	Red
VB-660i-YW-DIY	 Brake Block Replacement	72 mm	14 g	Yellow
VB-660i-GY-DIY	 Brake Block Replacement	72 mm	14 g	Grey

ITEM NO.		DESCRIPTION	COMPATIBILITY	WEIGHT	COLOR
VB-696-DIY		MTB Performance	72 mm	56 g	Black & Red/ Black
VB-696i-DIY		Brake Block Replacement	72 mm	12 g	Black & Red
VB-691-DIY		New Groove Design MTB Performance	72 mm	54 g	Black/ Silver
VB-692-DIY		New Groove Design MTB Performance	72 mm	54 g	Black/ Black
VB-692-1-DIY		New Groove Design MTB Performance	72 mm	54 g	Triple/ Silver
VB-692-1i-DIY		Brake Block Replacement	72 mm	12 g	Triple
VB-600-RD-DIY		MTB Reliable	72 mm	56 g	Red
VB-600-OR-DIY		MTB Reliable	72mm	56 g	Orange
VB-600-BL-DIY		MTB Reliable	72mm	56 g	Blue
VB-600-WH-DIY		MTB Reliable	72mm	56 g	White
VB-600-PK-DIY		MTB Reliable	72mm	56 g	Pink

ITEM NO.	DESCRIPTION	COMPATIBILITY	WEIGHT	COLOR
VB-600-LG-DIY	 MTB Reliable	72mm	56 g	Light Green
VB-600i-DIY	 Brake Block Replacement	72mm	10 g	Black
VB-600ic-DIY	 Brake Block Replacement	72mm	10 g	Green

RELIABLE MTB BRAKE SHOES

- Threaded type holder. Cartridge type brake block.
- All-weather available.
- Suitable for V-Brake, Alloy rims.

ITEM NO.	DESCRIPTION	COMPATIBILITY	WEIGHT	COLOR
VB-630-DIY	 Auto Adjust Brake Shoes MTB Performance	72 mm	76 g	Black
VB-664-DIY	 MTB Reliable	72mm	65 g	Black
VB-632-DIY	 MTB Reliable	60 mm	64 g	Black
VB-697-DIY	 MTB Reliable	72 mm	64 g	Triple & Black
VB-693-DIY	 MTB Reliable	72 mm	74 g	Black
VB-610-DIY	 MTB Reliable	72 mm	66 g	Black
VB-610-1-DIY	 MTB Reliable	72 mm	66 g	Red

BRAKE SHOES



ITEM NO.		DESCRIPTION	COMPATIBILITY	WEIGHT	COLOR
VB-610-2-DIY		MTB Reliable	72 mm	66 g	Yellow
VB-610-3-DIY		MTB Reliable	72 mm	66 g	Blue
VB-610-BR-DIY		MTB Reliable	72 mm	66 g	Red & Black
VB-610-BY-DIY		MTB Reliable	72 mm	66 g	Yellow & Black
VB-610-BB-DIY		MTB Reliable	72 mm	66 g	Blue & Black
VB-610-TR-DIY		MTB Reliable	72 mm	60 g	Transparent/ Light Grey
VB-620-DIY		MTB Reliable	70 mm	64 g	Black
VB-620-RD-DIY		MTB Reliable	70 mm	64 g	Red
VB-620-1-DIY		MTB Reliable	70 mm	64 g	Yellow & Black
VB-620-2-DIY		MTB Reliable	70 mm	64 g	Blue & Black
VB-620-3-DIY		MTB Reliable	70 mm	64 g	Red & Black
VB-620-4-DIY		MTB Reliable	70 mm	64 g	Grey & Black

CANTI LEVER BRAKE SHOES



- For Canti lever brake shoes.
- For alloy rims.

ITEM NO.	DESCRIPTION	COMPATIBILITY	WEIGHT	COLOR
VB-695-DIY	 Canti lever post type. New groove design.	72mm	42 g	Black/ Silver
VB-701-DIY	 Aluminum post type.	70mm	44 g	Black/ Silver
VB-703-DIY	 Aluminum post type.	72mm	44 g	Black/ Silver

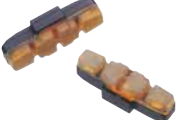
HYDRAULIC BRAKE SHOES

ITEM NO.	DESCRIPTION	COMPATIBILITY	WEIGHT	COLOR
HR-800i-DIY	 Hydraulic-activated brake shoes	For alloy rims	18 g	Black
HR-800i-1-DIY	 Hydraulic-activated brake shoes	For alloy rims	18 g	Red
HR-800ic-DIY	 Hydraulic-activated brake shoes	For ceramic rims.	18 g	Orange



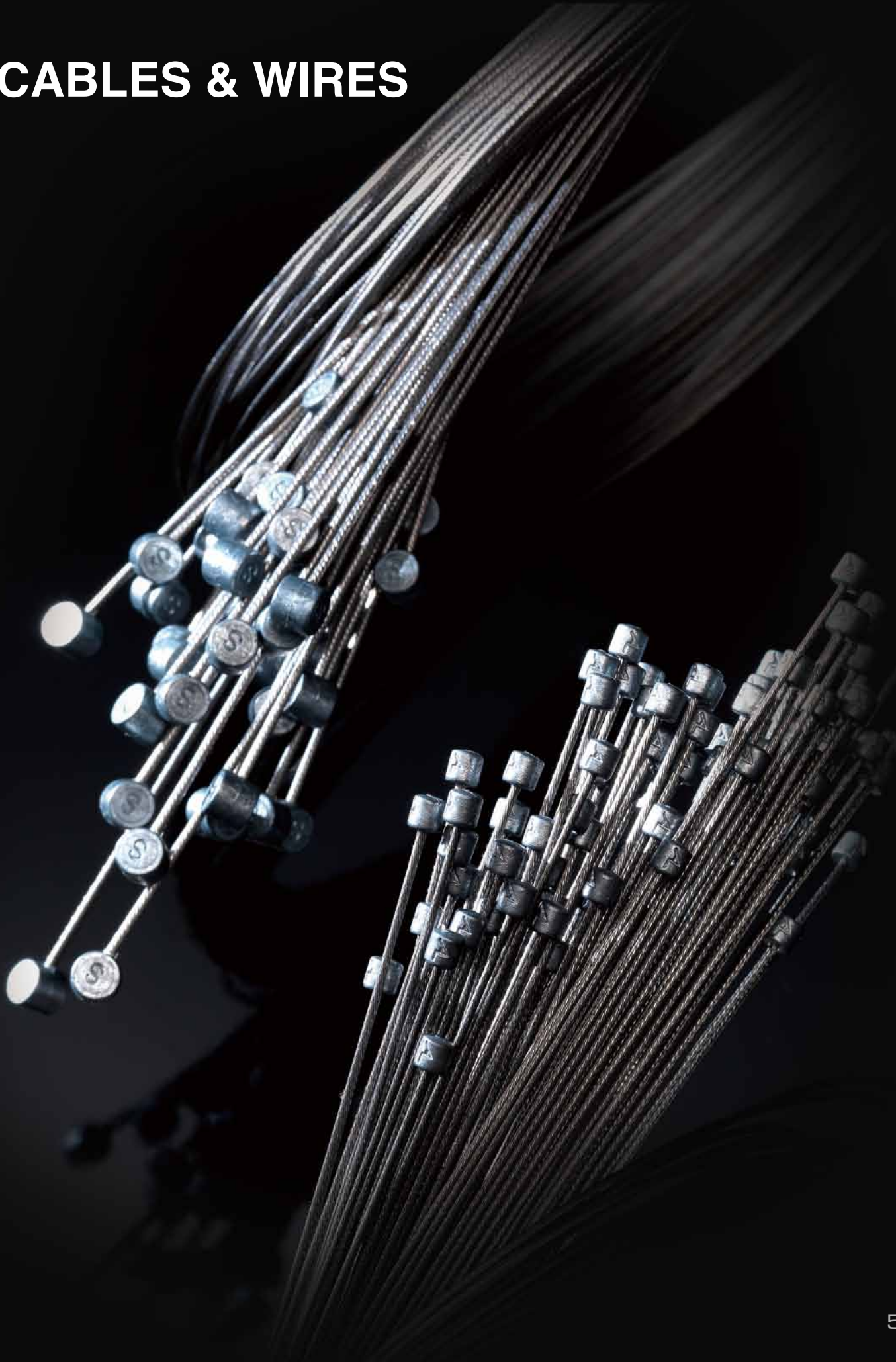

BMX BRAKE SHOES

ITEM NO.	DESCRIPTION	COMPATIBILITY	WEIGHT	COLOR
BMX-910-DIY	 BMX Brake shoes	For alloy rims, 40mm	46 g	Black
BMX-900-DIY	 BMX Brake shoes	For alloy rims, 40mm	46 g	White

CABLES & WIRES

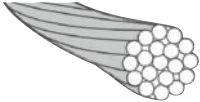
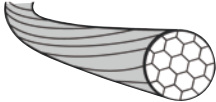
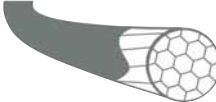
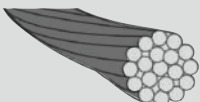

ALLIGATOR INNER CABLES LEVEL

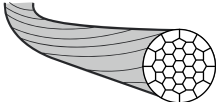
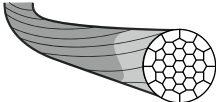
LEVEL	ECONOMY ☆☆	RELIABLE ☆☆☆	PERFORMANCE ☆☆☆☆	PROFESSIONAL ☆☆☆☆☆
MATERIAL / FILAMENT	BASIC	SLICK	P.T.F.E	SUPERIOR SHINE
Galvanized Steel 19 Strands				
Stainless Steel 19 Strands				
Stainless Steel 31 Strands				

SPECIAL TREATMENT

Superior Shine - ALLIGATOR special coating treatment, it's 3 times longer life than other inner cables, reduces friction and much smoother than P.T.F.E coated. Especially, it's Eco-friendly and non-toxic.

P.T.F.E. Coated - After P.T.F.E. procedure, the slick structure wire become thermo bonded to drastically improve brake & shift performance in all-weather condition. It also reduces friction well.
Special colors – White, Green, Red, Pink...

Slick - After slick procedure, basic structure wire become solid and its surface become smoother.

ZINC-NIPPLE



- All the inner cable have this logo are made by ALLIGATOR CABLES & WIRE.

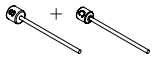

- Universal Shift: Shimano / Sram & Campagnolo

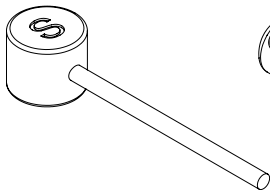

Universal Mountain Brake
7 x 6 mm

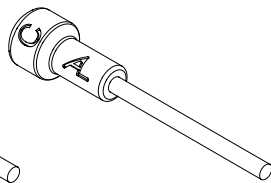

Campagnolo Road Brake
5.5 x 11.5 mm

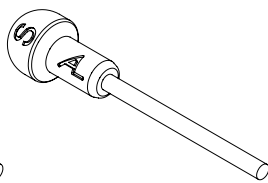

Shimano / SRAM Road Brake
6 x 11 mm

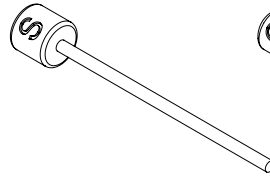

Shimano / SRAM Shift
4.4 x 4.4 mm

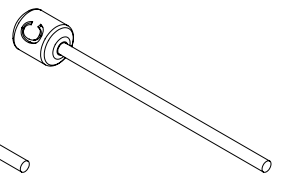

Campagnolo Shift
3.9 x 5 mm

BRAKE INNER CABLE



Headers Card



20 Cards/Display Box



100 pcs Volume Box

SUPERIOR SHINE

ITEM NO.	MATERIAL	COMPATIBILITY	DIAMETER	LENGTH	Q'TY
LY-B31SSSGUB	31-strand Superior Shine Slick Stainless	MTB	1.5mm	1700 mm	1Pc/ Card
LY-B31SSSGUB -S	31-strand Superior Shine Slick Stainless	Shimano & Sram Road	1.5mm	1700 mm	1 Pc/ Card
LY-B31SSSGUB-C	31-strand Superior Shine Slick Stainless	Campagnolo Road	1.5mm	1700 mm	1 Pc/ Card
LY-BSG17UB	19-strand Superior Shine Slick Stainless	MTB/ Shimano & Sram Road	1.5mm	1700 mm	1 Pc/ Card
LY-BSG17UB-C	19-strand Superior Shine Slick Stainless	MTB / Campagnolo Road	1.5mm	1700 mm	1 Pc/ Card
LY-B31SSSG17	31-strand Superior Shine Slick Stainless	MTB	1.5mm	1700 mm	20 Cards/ Box
LY-B31SSSG17-S	31-strand Superior Shine Slick Stainless	Shimano & Sram Road	1.5mm	1700 mm	20 Cards/ Box
LY-B31SSSG17-C	31-strand Superior Shine Slick Stainless	Campagnolo Road	1.5mm	1700 mm	20 Cards/ Box
LY-BSG17	19-strand Superior Shine Slick Stainless	MTB/ Shimano & Sram Road	1.5mm	1700 mm	20 Cards/ Box
LY-BSG17-C	19-strand Superior Shine Slick Stainless	MTB / Campagnolo Road	1.5mm	1700 mm	20 Cards/ Box
LY-B31SSSG761617	31-strand Superior Shine Slick Stainless	MTB	1.5mm	1700 mm	100 Pcs/ Box
LY-B31SSSG6101617	31-strand Superior Shine Slick Stainless	Shimano & Sram Road	1.5mm	1700 mm	100 Pcs/ Box
LY-B31SSSG55101617	31-strand Superior Shine Slick Stainless	Campagnolo Road	1.5mm	1700 mm	100 Pcs/ Box
LY-BSG761617	19-strand Superior Shine Slick Stainless	MTB	1.5mm	1700 mm	100 Pcs/ Box
LY-BSG6101617	19-strand Superior Shine Slick Stainless	Shimano & Sram Road	1.5mm	1700 mm	100 Pcs/ Box
LY-BSG55101617	19-strand Superior Shine Slick Stainless	Campagnolo Road	1.5mm	1700 mm	100 Pcs/ Box

P.T.F.E. COATED

ITEM NO.	MATERIAL	COMPATIBILITY	DIAMETER	LENGTH	Q'TY
LY-BSTPT17UB	19-strand P.T.F.E. coated Slick Stainless	MTB/ Shimano & Sram Road	1.6mm	1700 mm	1 Pc/ Card
LY-BSTPT17UB-C	19-strand P.T.F.E. coated Slick Stainless	MTB / Campagnolo Road	1.6mm	1700 mm	1 Pc/ Card
LY-BPT17UB	19-strand P.T.F.E. coated Slick Galvanized	MTB/ Shimano & Sram Road	1.6mm	1700 mm	1 Pc/ Card
LY-BSTPT17	19-strand P.T.F.E. coated Slick Stainless	MTB/ Shimano & Sram Road	1.6mm	1700 mm	20 Cards/ Box
LY-BSTPT17-C	19-strand P.T.F.E. coated Slick Stainless	MTB / Campagnolo Road	1.6mm	1700 mm	20 Cards/ Box
LY-BPT17	19-strand P.T.F.E. coated Slick Galvanized	MTB/ Shimano & Sram Road	1.6mm	1700 mm	20 Cards/ Box
LY-BSTPT761617	19-strand P.T.F.E. coated Slick Stainless	MTB	1.6mm	1700 mm	100 Pcs/ Box
LY-BSTPT6101617	19-strand P.T.F.E. coated Slick Stainless	Shimano/ Sram Road	1.6mm	1700 mm	100 Pcs/ Box
LY-BSTPT55101617	19-strand P.T.F.E. coated Slick Stainless	Campagnolo Road	1.6mm	1700 mm	100 Pcs/ Box
LY-BPT761617	19-strand Slick P.T.F.E. coated Galvanized	MTB	1.6mm	1700 mm	100 Pcs/ Box
LY-BPT6101617	19-strand Slick P.T.F.E. coated Galvanized	Shimano/ Sram Road	1.6mm	1700 mm	100 Pcs/ Box

SLICK

ITEM NO.	MATERIAL	COMPATIBILITY	DIAMETER	LENGTH	Q'TY
LY-B31SS17UB	31-strand Slick Stainless	MTB	1.5mm	1700 mm	1 Pc/ Card
LY-B31SS17UB -S	31-strand Slick Stainless	Shimano & Sram Road	1.5mm	1700 mm	1 Pc/ Card
LY-B31SS17UB-C	31-strand Slick Stainless	Campagnolo Road	1.5mm	1700 mm	1 Pc/ Card
LY-BSTSK17UB	19-strand Slick Stainless	MTB/ Shimano & Sram Road	1.5mm	1700 mm	1 Pc/ Card
LY-BSTSK17UB-C	19-strand Slick Stainless	MTB / Campagnolo Road	1.5mm	1700 mm	1 Pc/ Card
LY-BSK17UB	19-strand Slick Galvanized	MTB/ Shimano & Sram Road	1.5mm	1700 mm	1 Pc/ Card
LY-B31SS17	31-strand Slick Stainless	MTB Brake	1.5mm	1700 mm	20 Cards/ Box
LY-B31SS17-S	31-strand Slick Stainless	Shimano/ Sram Brake	1.5mm	1700 mm	20 Cards/ Box
LY-B31SS17UB-C	31-strand Slick Stainless	Campagnolo Brake	1.5mm	1700 mm	20 Cards/ Box
LY-BSTSK17	19-strand Slick Stainless	MTB/ Shimano & Sram Road	1.5mm	1700 mm	20 Cards/ Box
LY-BSTSK17UB-C	19-strand Slick Stainless	MTB / Campagnolo Road	1.5mm	1700 mm	20 Cards/ Box
LY-B31SS761617	31-strand Slick Stainless	MTB	1.5mm	1700 mm	100 Pcs/ Box
LY-B31SS6101617	31-strand Slick Stainless	Shimano & Sram Road	1.5mm	1700 mm	100 Pcs/ Box
LY-B31SS55101617	31-strand Slick Stainless	Campagnolo Road	1.5mm	1700 mm	100 Pcs/ Box
LY-BSTSK761617	19-strand Slick Stainless	MTB	1.5mm	1700 mm	100 Pcs/ Box
LY-BSTSK6101617	19-strand Slick Stainless	Shimano & Sram Road	1.5mm	1700 mm	100 Pcs/ Box
LY-BSTSK55101617	19-strand Slick Stainless	Campagnolo Road	1.5mm	1700 mm	100 Pcs/ Box
LY-BSK761617	19-strand Slick Galvanized	MTB	1.5mm	1700 mm	100 Pcs/ Box
LY-BSK6101617	19-strand Slick Galvanized	Shimano & Sram Road	1.5mm	1700 mm	100 Pcs/ Box

BASIC

ITEM NO.	MATERIAL	COMPATIBILITY	DIAMETER	LENGTH	Q'TY
LY-BST17UB	19-strand Stainless	MTB/ Shimano & Sram Road	1.6mm	1700 mm	1 Pc/ Card
LY-BRG17UB	19-strand Galvanized steel	MTB/ Shimano & Sram Road	1.6mm	1700 mm	1 Pc/ Card
LY-BST761617	19-strand Stainless	MTB	1.6mm	1700 mm	100 Pcs/ Box
LY-BST6101617	19-strand Stainless	Shimano & Sram Road	1.6mm	1700 mm	100 Pcs/ Box
LY-BRG761617	19-strand Galvanized steel	MTB	1.6mm	1700 mm	100 Pcs/ Box
LY-BRG6101617	19-strand Galvanized steel	Shimano & Sram Road	1.6mm	1700 mm	100 Pcs/ Box

SHIFT INNER CABLES

SUPERIOR SHINE

ITEM NO.	MATERIAL	COMPATIBILITY	DIAMETER	LENGTH	Q'TY
LY-S31SSSG20UD-S	31-strand Superior Shine Slick Stainless	Shimano/ Sram	1.1mm	2000 mm	1 Pc/ Card
LY-S31SSSG20UD-C	31-strand Superior Shine Slick Stainless	Campagnolo	1.1mm	2000 mm	1 Pc/ Card
LY-SSG20UD	19-strand Superior Shine Slick Stainless	Universal Shift	1.1mm	2000 mm	1 Pc/ Card
LY-S31SSSG20-S	31-strand Superior Shine Slick Stainless	Shimano/ Sram	1.1mm	2000 mm	20 Cards/ Box
LY-S31SSSG20-C	31-strand Superior Shine Slick Stainless	Campagnolo	1.1mm	2000 mm	20 Cards/ Box
LY-SSG20	19-strand Superior Shine Slick Stainless	Universal Shift	1.1mm	2000 mm	20 Cards/ Box
LY-S31SSSG43520	31-strand Superior Shine Slick Stainless	Shimano/ Sram	1.1mm	2000 mm	100 Pcs/ Box
LY-S31SSSG39520	31-strand Superior Shine Slick Stainless	Campagnolo	1.1mm	2000 mm	100 Pcs/ Box
LY-SSG43520	19-strand Superior Shine Slick Stainless	Shimano/ Sram	1.1mm	2000 mm	100 Pcs/ Box
LY-SSG39520	19-strand Superior Shine Slick Stainless	Campagnolo	1.1mm	2000 mm	100 Pcs/ Box

P.T.F.E. COATED

ITEM NO.	MATERIAL	COMPATIBILITY	DIAMETER	LENGTH	Q'TY
LY-SSTPT20UD	19-strand P.T.F.E. coated Slick Stainless	Universal Shift	1.2mm	2000 mm	1 Pc/ Card
LY-SPT20UD	19-strand P.T.F.E. coated Slick Galvanized	Universal Shift	1.2mm	2000 mm	1 Pc/ Card
LY-SSTPT20	19-strand P.T.F.E. coated Slick Stainless	Universal Shift	1.2mm	2000 mm	20 Cards/ Box
LY-SPT20	19-strand P.T.F.E. coated Slick Galvanized	Universal Shift	1.2mm	2000 mm	20 Cards/ Box
LY-SSTPT43520	19-strand P.T.F.E. coated Slick Stainless	Shimano/ Sram	1.2mm	2000 mm	100 Pcs/ Box
LY-SSTPT39520	19-strand P.T.F.E. coated Slick Stainless	Campagnolo	1.2mm	2000 mm	100 Pcs/ Box
LY-SPT43520	19-strand P.T.F.E. coated Slick Galvanized	Shimano/ Sram	1.2mm	2000 mm	100 Pcs/ Box
LY-SPT395207	19-strand P.T.F.E. coated Slick Galvanized	Campagnolo	1.2mm	2000 mm	100 Pcs/ Box

SLICK

ITEM NO.	MATERIAL	COMPATIBILITY	DIAMETER	LENGTH	Q'TY
LY-S31SS20UD-S	31-strand Slick Stainless	Shimano/ Sram	1.1mm	2000 mm	1 Pc/ Card
LY-S31SS20UD-C	31-strand Slick Stainless	Campagnolo	1.1mm	2000 mm	1 Pc/ Card
LY-SSTSK20UD	19-strand Slick Stainless	Universal Shift	1.1mm	2000 mm	1 Pc/ Card
LY-SSK20UD	19-strand Slick Galvanized	Universal Shift	1.1mm	2000 mm	1 Pc/ Card
LY-S31SS20-S	31-strand Slick Stainless	Shimano/ Sram	1.1mm	2000 mm	20 Cards/ Box
LY-S31SS20-C	31-strand Slick Stainless	Campagnolo	1.1mm	2000 mm	20 Cards/ Box
LY-SSTSK20UD	19-strand Slick Stainless	Universal Shift	1.1mm	2000 mm	20 Cards/ Box
LY-S31SS43520	31-strand Slick Stainless	Shimano/ Sram	1.1mm	2000 mm	100 Pcs/ Box
LY-S31SS39520	31-strand Slick Stainless	Campagnolo	1.1mm	2000 mm	100 Pcs/ Box
LY-SSTSK43520	19-strand Slick Stainless	Shimano/ Sram	1.1mm	2000 mm	100 Pcs/ Box
LY-SSTSK39520	19-strand Slick Stainless	Campagnolo	1.1mm	2000 mm	100 Pcs/ Box
LY-SSK43520	19-strand Slick Galvanized	Shimano/ Sram	1.1mm	2000 mm	100 Pcs/ Box

BASIC

ITEM NO.	MATERIAL	COMPATIBILITY	DIAMETER	LENGTH	Q'TY
LY-SST20UD	19-strand Stainless	Shimano/ Sram	1.2mm	2000 mm	1 Pc/ Card
LY-SRG20UD	19-strand Galvanized steel	Shimano/ Sram	1.2mm	2000 mm	1 Pc/ Card
LY-SST43520	19-strand Stainless	Shimano/ Sram	1.2mm	2000 mm	100 Pcs/ Box
LY-SRG43520	19-strand Galvanized steel	Shimano/ Sram	1.2mm	2000 mm	100 Pcs/ Box

ALLIGATORILINK™

UNBREAKABLE LINK BETWEEN SAFETY & STYLE !



mini ALLIGATORILINK™ GEAR KIT

- The lightest alloy housing in the world.
- 50% lighter than standard ALLIGATORILINK.
- CNC Alloy housing for precision.
- INTERLINK™ Technology greatly reduce internal force for durability.
- 100% waterproof, compatible for all weather.



HOUSING	Aluminum Links (with INTERLINK™ technology)
OUTER DIAMETER	4.3 mm
LENGTH	1800 mm
INNER CABLE	19-strand P.T.F.E. coated Slick Galvanized
COMPATIBILITY	Shimano/Sram & Campagnolo
LENGTH	Front 1500 mm Rear 2200 mm
INNER TUBE	P.T.F.E. inner tube Front Tube 1600 mm Rear Tube 2300 mm
PARTS	X3 Front (Lever) Ferrule X3 Rear Ferrule X2 INTERLINK™ Bead X2 End cap X2 Silicone housing shield

UNIVERSAL SHIFT



Silver

LY-ILINK-S



Red

LY-ILINK-S-R



Black

LY-ILINK-S-B



Gold

LY-ILINK-S-G



Blue

LY-ILINK-S-BL



Merida Green

LY-ILINK-S-MG



STANDARD ALLIGATORILINK™ MTB GEAR KIT

- For Mountain Bike.
- 50% lighter than normal cable housings.
- Alloy housing technology for precision.
- 100% waterproof, compatible for all weather.
- Self-lubrication, low friction.



HOUSING	Aluminum Links (with INTERLINK™ technology)
OUTER DIAMETER	5.5 mm
LENGTH	1800 mm
INNER CABLE	19-strand P.T.F.E. coated Slick Galvanized
COMPATIBILITY	Shimano/Sram & Campagnolo
LENGTH	Front 1500 mm Rear 2200 mm
INNER TUBE	PE Inner Tube Front Tube 1600 mm Rear Tube 2300 mm
PARTS	X7 Front (Lever) Ferrule X4 Rear Ferrule X3 INTERLINK™ Bead X2 End cap X2 Silicone housing shield

MTB SHIFT



Silver

LY-ILINK-D



Red

LY-ILINK-D-R



Black

LY-ILINK-D-B



Gold

LY-ILINK-D-G



Blue

LY-ILINK-D-BL



Merida Green

LY-ILINK-D-MG







STANDARD ALLIGATORILINK™ BRAKE KIT

- 50% lighter than normal cable housings.
- Alloy housing technology for precision.
- 100% waterproof, compatible for all weather.
- Self-lubrication, low friction.
- Suitable for internal systems.









	EXTERNAL CABLE SYSTEM	INTERNAL CABLE SYSTEM
HOUSING	Aluminum Links (with INTERLINK™ technology)	Aluminum Links (with INTERLINK™ technology)
OUTTER DIAMETER	5,5 mm	5,5 mm
LENGTH	1500 mm	800 mm
INNER CABLE	19-strand P.T.F.E. coated Slick Galvanized	19-strand P.T.F.E. coated Slick Galvanized
COMPATIBILITY	Universal MTB & Shimano/Sram Road Universal MTB & Campagnolo Road	Universal MTB & Shimano/Sram Road Universal MTB & Campagnolo Road
LENGTH	Front Wire 900 mm Rear Wire 1700 mm	Front Wire 900 mm Rear Wire 1700 mm
INNER TUBE	PE inner tube Front Tube 1000 mm Rear Tube 1800 mm	PE inner tube Front Tube 1000 mm Rear Tube 1800 mm
PARTS	X2 Front (Lever) Ferrule (L) X2 Front (Lever) Ferrule (S) X1 Frame Stopper (Road) X3 Rear (Caliper) Ferrule X2 Rear Ferrule X2 INTERLINK™ Bead X2 End cap X2 Silicone housing shield	X3 Front (Lever) Ferrule (L) X5 Rear (Caliper) Ferrule X2 Rear Ferrule X2 Housing Connector X2 INTERLINK™ Bead X2 End cap X2 Silicone housing shield X1 1P Housing 1000 mm

EXTERNAL CABLE SYSTEM

						
	Silver	Red	Black	Gold	Blue	Merida Green
SHIMANO/SRAM	LY-ILINK-B	LY-ILINK-B-R	LY-ILINK-B-B	LY-ILINK-B-G	LY-ILINK-B-BL	LY-ILINK-B-MG
CAMPAGNOLO	LY-ILINK-B-C	LY-ILINK-B-R-C	LY-ILINK-B-B-C	LY-ILINK-B-G-C	LY-ILINK-B-BL-C	LY-ILINK-B-MG-C

INTERNAL CABLE SYSTEM

						
	Silver	Red	Black	Gold	Blue	Merida Green
SHIMANO/SRAM	LY-ILINK-B-IH	LY-ILINK-B-R-IH	LY-ILINK-B-B-IH	LY-ILINK-B-G-IH	LY-ILINK-B-BL-IH	LY-ILINK-B-MG-IH
CAMPAGNOLO	LY-ILINK-B-IH-C	LY-ILINK-B-R-IH-C	LY-ILINK-B-B-IH-C	LY-ILINK-B-G-IH-C	LY-ILINK-B-BL-IH-C	LY-ILINK-B-MG-IH-C

ALLIGATORILINK™ PARTS

• Parts and accessories of ALLIGATORILINK™ for different frames.



Front (Lever) Ferrule (L)
Standard-iLINK



Front (Lever) Ferrule (S)
Standard-iLINK



Front Frame Stopper
Standard-iLINK
Road bike Brake only



Lever side Ferrule
Standard-iLINK
Campagnolo only



Front Ferrule
mini-iLINK



Housing connector
Standard-iLINK
Internal System



Rear Ferrule



Rear (Caliper) Ferrule



Rear Ferrule
Standard-aiLINK
Brake



Rear Ferrule
Mini-iLINK



INTERLINK™ Bead
Standard-iLINK



INTERLINK™ Bead
mini-iLINK



Housing Shield
Standard-iLINK



Housing Shield
mini-iLINK



End Caps

INNER TUBE

ITEM NO.	DESCRIPTION
LY-PE-M50	50M PE TUBE for 5MM Standard-iLink
LY-PE-M10	10M PE TUBE for 5MM Standard-iLink
LY-MPTFE-M50	50M P.T.F.E. TUBE for 4MM mini-iLINK
LY-MPTFE-M10	10M P.T.F.E. TUBE for 4MM mini-iLINK



ALLIGATOR INTERLINK™ TECHNOLOGY

- Much stronger than other alloy housing.
- Fully protect inner cable and inner tube.
- All weather-proof.
- Durable, no internal force.
- Easy to assemble and take off.

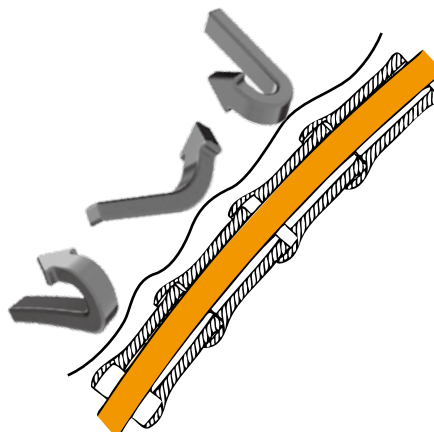



ALLIGATOR® | DIY CABLE KIT

SUPER LIGHT

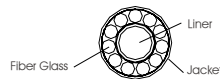
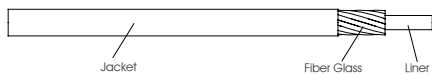

- Super light for professional.
- 60% lighter than ordinary shifting cable housing.
- Fiber glass outer housing.
- Compressionless.
- Use 31-strand superior shine slick stainless inner wire.

SHIFT - UNIVERSAL

HOUSING	INNER WIRE	ACCESSORIES KIT			
5mm FGSP Length: 2000 mm	31-Strand Superior Shine Slick Stainless Front: Front : 1.1 mm X 1500 mm Rear : 1.1 mm X 2000 mm				
<p>Yellow</p> <p>LY-SL31SSSG</p>	<p>Black</p> <p>LY-SL31SSSG-BK</p>				

BULLET PROOF™

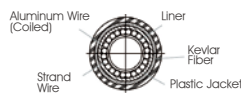
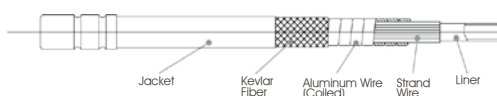

- Kevlar fiber. Aluminum wire and strand wire for durability.
- Compressionless.

BRAKE - SHIMANO/SRAM, CAMPAGNOLO

HOUSING	INNER WIRE	ACCESSORIES KIT			
5mm KSP Length: 2300 mm	P.T.F.E coated Stainless Front : 1.6 mm X 1000 mm Rear : 1.6 mm X 2000 mm				
<p>SHIMANO/SRAM</p> <p>CAMPAGNOLO</p>	<p>Smoke Yellow</p> <p>LY-KSPTB</p> <p>LY-KSPTB-C</p>				

SHIFT - UNIVERSAL

HOUSING	INNER WIRE	ACCESSORIES KIT			
5mm KSP Length: 2000 mm	P.T.F.E coated Stainless Front : 1.2 mm X 1500 mm Rear : 1.2 mm X 2000 mm				
<p>Smoke Yellow</p> <p>LY-KSPTS</p>					

SUPER FORTRESS™

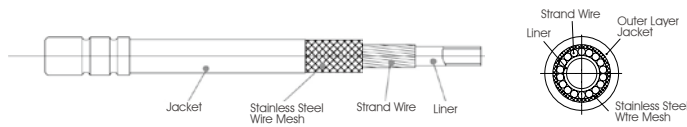

- High quality flexible cable housing.
- Strengthened with braided stainless steel mesh.
- Enhance smooth shifting & braking by reducing friction.
- Compressionless housing for dependability.
- Self-lubrication.



BRAKE - SHIMANO/SRAM, CAMPAGNOLO

HOUSING	INNER WIRE		ACCESSORIES KIT				
5 mm STSP Length: 2300 mm	P.T.F.E coated Stainless Front : 1.6 mm X 1000 mm Rear : 1.6 mm X 2000 mm			HPA08-BK 	IHPA09-BK 	IPR08 	IPA03
	Clear Black 	Clear 	Black 	White 	Red 		
SHIMANO/SRAM	LY-SFPTB	LY-SFPTB-CL	LY-SFPTB-BK	LY-SFPTB-WH	LY-SFPTB-RD		
CAMPAGNOLO	LY-SFPTB-C	LY-SFPTB-CL-C	LY-SFPTB-BK-C	LY-SFPTB-WH-C	LY-SFPTB-RD-C		
	Blue 	Purple 	Yellow 	Orange 	Apple Green 		
SHIMANO/SRAM	LY-SFPTB-BL	LY-SFPTB-PU	LY-SFPTB-YW	LY-SFPTB-OR	LY-SFPTB-AG		
CAMPAGNOLO	LY-SFPTB-BL-C	LY-SFPTB-PU-C	LY-SFPTB-YW-C	LY-SFPTB-OR-C	LY-SFPTB-AG-C		

SHIFT - UNIVERSAL

HOUSING	INNER WIRE		ACCESSORIES KIT				
5 mm STSP Length: 2000 mm	P.T.F.E coated Stainless Front : 1.2 mm X 1500 mm Rear : 1.2 mm X 2000 mm			HPA08-BK 	IHPA09-BK 	IPR04 	IPA03
	Clear Black 	Clear 	Black 	White 	Red 		
	LY-SFPTS	LY-SFPTS-CL	LY-SFPTS-BK	LY-SFPTS-WH	LY-SFPTS-RD		
	Blue 	Purple 	Yellow 	Orange 	Apple Green 		
	LY-SFPTS-BL	LY-SFPTS-PU	LY-SFPTS-YW	LY-SFPTS-OR	LY-SFPTS-AG		

SLEEK GLIDE™

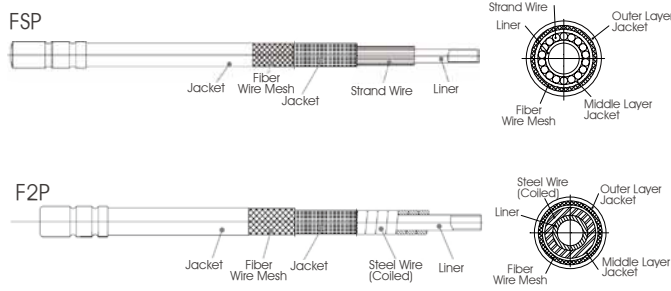

- High performance
- Fiber mesh braided.
- Strand wire for durability.
- Compressionless.



BRAKE - SHIMANO/SRAM, CAMPAGNOLO

HOUSING	INNER WIRE		ACCESSORIES KIT			
5mm F2P Length: 2300 mm	Galvanized P.T.F.E coated Front : 1.6 mm X 1000 mm Rear : 1.6 mm X 2000 mm					
	SILVER	Gold	Smoke Black	White		
SHIMANO/SRAM	LY-BPTFE	LY-BPTGN	LY-BPTSB	LY-BPTWH		
CAMPAGNOLO	LY-BPTFE-C	LY-BPTGN-C	LY-BPTSB-C	LY-BPTWH-C		
	Red	Blue	Pink	Gold/Silver		
SHIMANO/SRAM	LY-BPTRD	LY-BPTBL	LY-BPTPK	LY-BPTGS		
CAMPAGNOLO	LY-BPTRD-C	LY-BPTBL-C	LY-BPTPK-C	LY-BPTGS-C		

SHIFT - UNIVERSAL

HOUSING	INNER WIRE		ACCESSORIES KIT			
5mm FSP Length: 2000 mm	Galvanized P.T.F.E coated Front : 1.2 mm X 1500 mm Rear : 1.2 mm X 2000 mm					
	SILVER	Gold	Smoke Black	White		
	LY-SPTFE5	LY-SPTGN	LY-SPTSB	LY-SPTWH		
	Red	Blue	Pink	Gold/Silver		
	LY-SPTRD	LY-SPTBL	LY-SPTPK	LY-SPTGS		

SILVER STAR

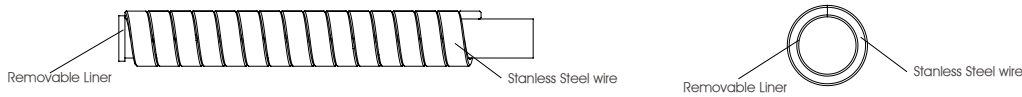

- Flexible cable housing.
- Eco-friendly.
- Easier to separate tube and housing for recycling.



BRAKE - SHIMANO/SRAM, CAMPAGNOLO

HOUSING	INNER WIRE	ACCESSORIES KIT		
5mm Silver Star Length: 2300 mm	31-Strand Super Shine Slick Stainless Front : 1.6 mm X 1000 mm Rear : 1.6 mm X 2000 mm			
		PE TUBE 2500 mm	DHPR13-OR-AL	
SHIMANO/SRAM CAMPAGNOLO	LY-BSSPTFE LY-BSSPTFE-C			

SHIFT - UNIVERSAL

HOUSING	INNER WIRE	ACCESSORIES KIT		
5mm Silver Star Length: 2000 mm	31-Strand Super Shine Slick Stainless Front : 1.1 mm X 1500 mm Rear : 1.1 mm X 2000 mm			
		PE TUBE 2400 mm	DHPR13-OR-AL	
	LY-SSSPTFE			

RELIABLE 11 SPEEDS SP SHIFT

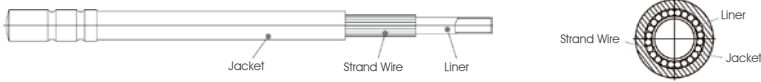

- New structure SP housing for shift, especially for 11 speeds.
- Smoother, softer and more sensitive for shifting.
- Compressionless, steel strand wire for maximum use.

SHIFT - UNIVERSAL

HOUSING	INNER WIRE	ACCESSORIES KIT
---------	------------	-----------------

4mm SP 11S
Length: 2000 mm

Slick Galvanized
Front :1.1 mm X 1500 mm
Rear : 1.1 mm X 2000 mm

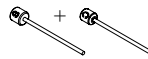

Black LY-ERK11S	Gray LY-ERK11SGY	White LY-ERK11SWH	Red LY-ERK11SRD
Blue LY-ERK11SBL	Yellow LY-ERK11SYW	Merida Green LY-ERK11SMG	Orange LY-ERK11SMO

RELIABLE 2P BRAKE

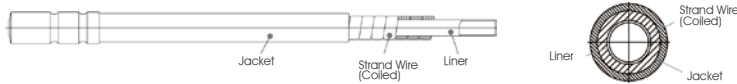

- Coiled housing.
- Non-toxic polyvinyl outer jacket ensures longevity.

BRAKE - MTB, SHIMANO/ SRAM

HOUSING	INNER WIRE	ACCESSORIES KIT
---------	------------	-----------------

5mm 2P
Length: 2300 mm

Slick Galvanized
Front :1.5 mm X 1000 mm
Rear : 1.5 mm X 2000 mm



Black LY-ERKB	Gray LY-ERKBGY	White LY-ERKBWH	Red LY-ERKBRD
Blue LY-ERKBBL	Yellow LY-ERKBYW	Merida Green LY-ERKBMG	Maxxis Orange LY-ERKBMO

HOUSING & CABLE SET

- 1 piece housing & inner wire DIY set.
- Installed ferrule and parts.
- Competibility : Brake for MTB, Shimano/Sram.
Shift for Shimano/Sram, Campagnolo



Headers Card



Headers Card



Headers Card

ITEM NO.	COLOR	LENGTH	HOUSING	INNER WIRE	BRAKE/ SHIFT
LY-220UB01	Black	60" X 65"			
LY-220UB02	White	60" X 65"	5mm 2P Economy Housing	Galvanized Steel	Brake
LY-220UB14	Gray	60" X 65"			
LY-220UBRD	Red	60" X 65"			
LY-220UD01	Black	70" X 75"			
LY-220UD02	White	70" X 75"	5mm 2P Economy Housing	Galvanized Steel	Shift
LY-220UD14	Gray	70" X 75"			
LY-220UDRD	Red	70" X 75"			
LY-186UB	Transparent Black	60" X 65"			
LY-186UBWH	White	60" X 65"	5mm ST.SP Super Fortress™	PTFE Stainless	Brake
LY-186UBRD	Red	60" X 65"			
LY-186UD	Transparent Black	70" X 75"			
LY-186UDWH	White	70" X 75"	5mm ST.SP Super Fortress™	PTFE Stainless	Shift
LY-186UDRD	Red	70" X 75"			
LY-886UB	Silver	60" X 65"	5mm F2P Sleek Glide™	PTFE Galvanized	Brake
LY-668UBGN	Gold	60" X 65"			
LY-888UD	Silver	70" X 75"	5mm FSP Sleek Glide™	PTFE Galvanized	Shift
LY-666UDGN	Gold	70" X 75"			

30M HOUSING VOLUME BOX

- Much convenience for bikes shop to replace housings for customers.
- A variety of colors for your preferences.

Recommendation: Page 81 - ALLIGATOR CABLE HOUSING CUTTER



PROFESSIONAL & PERFORMANCE

ITEM NO.	COLOR	DESCRIPTION	BRAKE/ SHIFT
LY-88030	Smoke Yellow	KSP, 5mm - Bullet Proof - Professional	Brake/ Shift
LY-99930YW	Yellow	FGSP 5mm - Super Light - Professional	Shift
LY-99930BK	Black	FGSP 5mm - Super Light - Professional	Shift
LY-18630	Clear Black		
LY-18630BK	Black		
LY-18630WH	White		
LY-18630RD	Red		
LY-18630BL	Blue	ST.SP. 5mm - Super Fortress - Professional	Brake/ Shift
LY-18630AG	Apple Green		
LY-18630PU	Purple		
LY-18630YW	Yellow		
LY-18630OR	Orange		
LY-88830	Silver		
LY-66630	Gold		
LY-66630SB	Smoke Black		
LY-66630WH	White	FSP, 5mm – Sleek Glide - Performance	Shift
LY-66630RD	Red		
LY-66630BL	Blue		
LY-66630GS	Gold Silver		
LY-66630PK	Pink		
LY-88630	Silver		
LY-66830	Gold		
LY-66830SB	Smoke Black		
LY-66830WH	White	F2P, 5mm – Sleek Glide - Performance	Brake
LY-66830RD	Red		
LY-66830BL	Blue		
LY-66830GS	Gold Silver		
LY-66830PK	Pink		

RELIABLE & ECONOMY

ITEM NO.	COLOR	DESCRIPTION	BRAKE/ SHIFT
LY-16611S30	Black		
LY-16611S3002	White		
LY-16611S3014	Gray	SP 4 mm - Reliable Suitable for 11 speeds shift	Shift
LY-16611S30RD	Red		
LY-16611S30BL	Blue		
LY-16630	Black		
LY-1663002	White		
LY-1663014	Gray		
LY-16630RD	Red		
LY-16630BL	Blue	SP 4mm – Reliable	Shift
LY-16630YW	Yellow		
LY-16630PK	Pink		
LY-16630MO	Maxxis orange		
LY-16630MG	Merida green		
LY-16830	Black		
LY-1683014	Gray	SP 5mm – Economy	Shift
LY-22030	Black		
LY-2203002	White		
LY-2203014	Gray		
LY-22030RD	Red		
LY-22030BL	Blue	2P 5mm – Economy	Brake
LY-22030YW	Yellow		
LY-22030PK	Pink		
LY-22030MO	Maxxis orange		
LY-22030MG	Merida green		
LY-26630	Black	ALS 2P 4mm - Reliable	Shift
LY-26830	Black	ALS 2P 5mm - Reliable	Brake

SEALED CABLE HOUSING

- Pre-lubed, sealed compressionless housing and sealed ferrule.
- This design ensures that contaminants don't enter the cable system.
- Additionally, the system is lined with a POLYETHYLENE inner for low friction and efficient shifting.

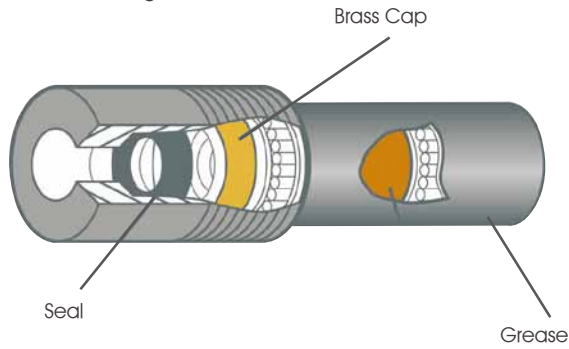

ITEM NO.	DESCRIPTION	COLOR	QUANTITY
LY-16630001	SP 4mm x 300mm	Black	50 Pcs
LY-16630014	SP 4mm x 300mm	Grey	50 Pcs
LY-16660001	SP 4mm x 600mm	Black	50 Pcs
LY-16660014	SP 4mm x 600mm	Grey	50 Pcs
LY-16830001	SP 5mm x 300mm	Black	50 Pcs
LY-16830014	SP 5mm x 300mm	Grey	50 Pcs
LY-16860001	SP 5mm x 600mm	Black	50 Pcs
LY-16860014	SP 5mm x 600mm	Grey	50 Pcs

50 PCS/ HANGING DISPLAY BOX







Cleaning & Lubrication Set Display Box

DRY-TYPE LUBRICANT

HK-LLU01 Use on Chains, Gears, Derailleur 120 ml

- Available in dusty, rocky, dirty environment.
- To keep bikes in the best operating condition, the chain and derailleur need different lubricants in different climate conditions and different situations.
- Semi-dry lubricant provides the lubricating performance needed in dusty, rocky, and dirty environments to keep bicycle chain, chain wheel and derailleur well lubricated at race speeds.



WET-TYPE LUBRICANT

HK-LLU02 Use on Chains, Gears, Derailleur 120 ml

- Keep out damp and dust.
- In damp situations and wet places, Wet-type lubricant will ensure that bicycle chains, gears and derailleur can resist wet wear. It will also keep bicycle chains well-lubricated at race speeds.
- Effectively keep out damp and dust. Preventing damage and ensure superior performance of lubricant.



P.T.F.E. LUBRICANT

HK-LLU03 Use on Chains, Gears, Derailleur 120 ml

- Reduce friction, prolongs chain life.
- P.T.F.E. is formulated to work and last under severe riding condition. P.T.F.E. spray provides excellent lubrication and a shield that reduces friction and prolongs chain life.



PARTS ANTI-SLIP CREAM

HK-LLU04 Use on Seat post, Handle bar, Bar end

10 Pcs/ Box

- Increase friction, available for carbon fiber & aluminum.
- Special micro particles work to create increased friction.
 - Reduces required fastening torque by up to 30%.
 - Protects components from corrosion.
 - Eliminates creaking noises.
 - Evenly apply a thin film onto the surfaces being fastened together.



GOLDEN LUBRICANT

HK-LLU05 Use on B.B., Hub, Screw

80 ml

- Antirust, easy disassembly.
- Golden lubricant provides excellent lubricity with anti-jammed function. It could widely be applied in various kinds of bicycle components. It's excellent lubrication and its function of antirust offer the best disassembly.
- It's a superior sealant which protects components from dust and water. It also reduces squeaks and damages which caused by friction.



CHAIN & FREEWHEEL CLEANER

HK-LCL01 Use on Chain, Freewheel

120 ml

- Easy for cleaning chains and Freewheel.
- Dirt and contaminants will accumulate on moving parts such as tires, chain, freewheel and cables after riding.
- A new designed that is Eco-friendly and won't harm the environment.



NEUTRAL BIKE WASH

HK-LCL02 Use on all Bicycles

300 ml

- Cleaning dirty and dusty , always keep you bicycles like a new one.
- Passed European Reach Regulation.
- It's Eco-friendly and also safe to our skin or body.





**HIGH-TECH TOOLS
MAKE LIFE EASY !**

PORTABLE MELTING CUTTER SET

- Cutting wires in 3 seconds, easy to use and portable.
- Naturally forms a solid end so that wires will not split and hurt your fingers.
- You don't need end caps or cable bolts after cutting.
- With a fan in the melting cutter, prevents overheat.
- Easy to clean with Cleaner. Just put the melting cutter into cleaner, and it'll start cleaning automatically.

ITEM NO	DESCRIPTION	PACKAGE
LY-T99-DIY	1x The Melting Cutter 1x Electrical Control Box 1x Cleaner 1x Glove 1x Extra Brush	1 Set/ Carrying Box



Select the diameter (mm) of cables.
Not available for P.T.F.E. coated cables.



Melting and cutting cables.
Be careful the spark may hurt frames



Put your melting cutter in cleaner, it'll automatically start cleaning.

RELIABLE CABLE CUTTER

ITEM NO.	DESCRIPTION	COLOR	PACKAGE
LY-T06-DIY	ALLIGATOR reliable cable cutter makes your work easier.	Orange or Blue	1 Pc/ Header BOX
LY-T07-DIY		Black	1 Pc/ Header BOX

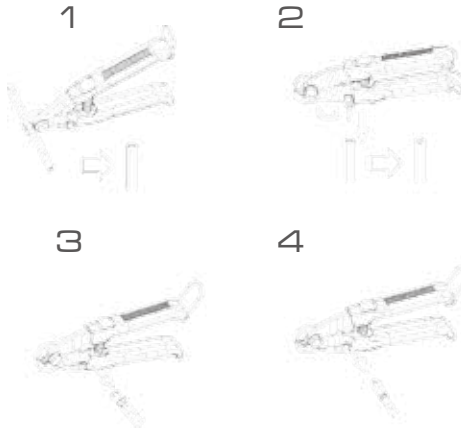
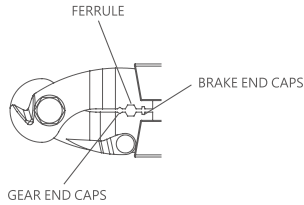

LY-T06-DIY



LY-T07-DIY



BIG JAW CRIMPER

ITEM NO.	DESCRIPTION	COLOR	PACKAGE
LY-T08-DIY	Easy to crimp end caps, ferrules on your cable housing perfectly.	Red	1 Pc/ Headers Box

EFFECTIVE TOOL FOR PRECISION CRIMPING

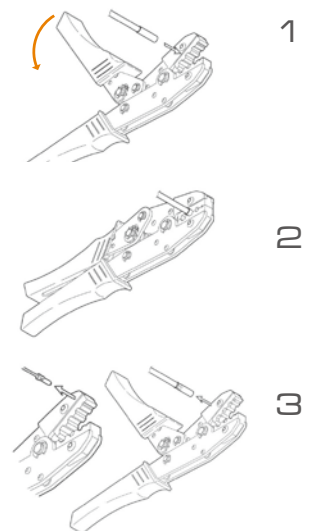
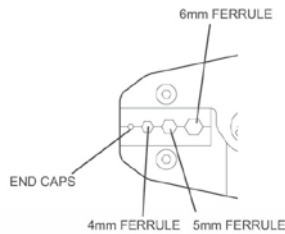

HYDRAULIC HOSE CUTTER

ANCHOR HYDRAULIC HOSE CUTTER

ITEM NO.	DESCRIPTION	COLOR	PACKAGE
HK-CUT005-DIY	New design for ergonomics. Include Blade for replacing. *Not suitable for stainless mesh hydraulic hose.* *Other Anodized Colors are available.*	Red	1 Pc/ Card



HOSE CUTTER

ITEM NO.	DESCRIPTION	COLOR	PACKAGE
HK-CUT001-DIY	Hydraulic hose cutter for Ultimate and other fiber braided hoses.	Blue	1 Pc/ Card

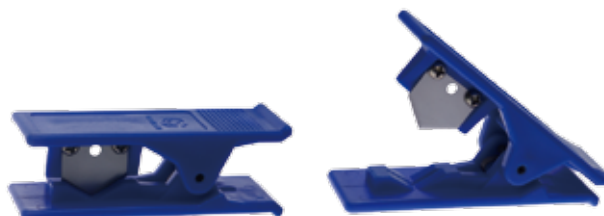
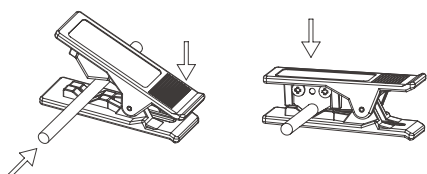

ITEM NO.	DESCRIPTION	COLOR	PACKAGE
HK-CUT003-DIY	Cutting hydraulic hose flawlessly that prevent inner tube from deforming.	Orange	1 Pc/ Card

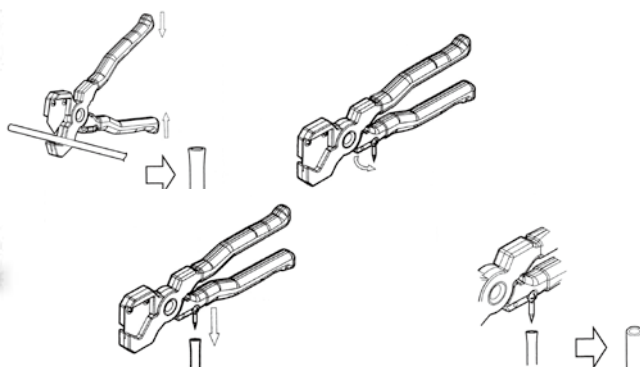

CENTER LOCK WRENCH

ITEM NO.	DESCRIPTION	COLOR	PACKAGE
HK-CLW01-DIY	Tools for center-lock ring.	Orange	1 Pc/ Card

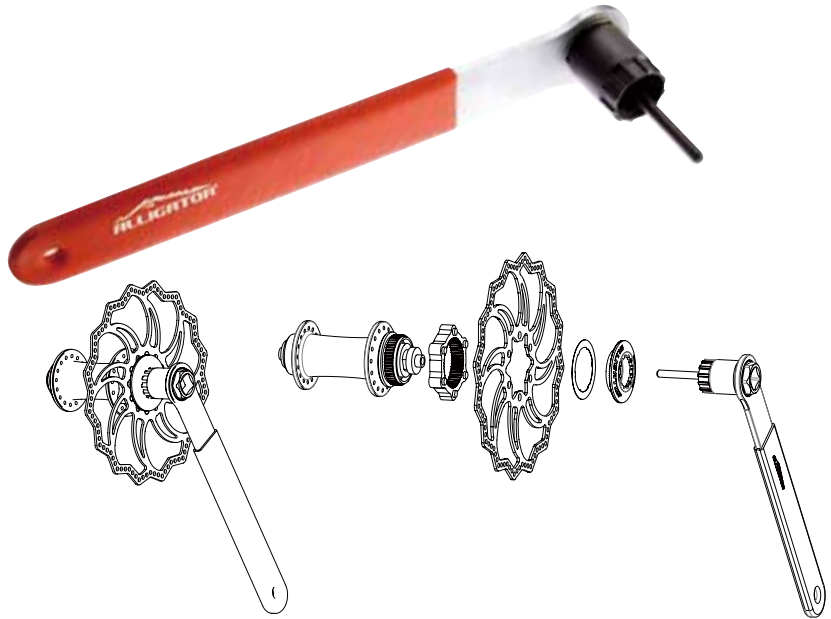

FREEWHEEL TURNER

ITEM NO.	DESCRIPTION	COLOR	PACKAGE
HK-FT01-DIY	Chain whip for multi speed use.	Orange	1 Pc/ Card

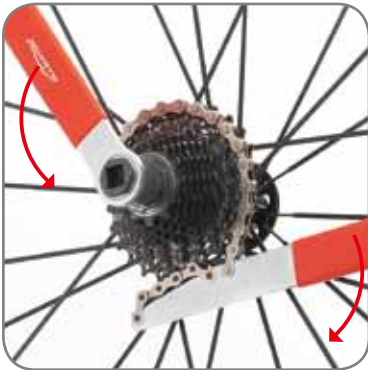

DISC RECOVERY

ITEM NO.	DESCRIPTION	COLOR	PACKAGE
HK-DR01-DIY	Recovers deformed disc rotors. Adjustable disc depth for precise bending.	Orange	1 Pc/ Card



CRANK WRENCH

ITEM NO.	DESCRIPTION	COLOR	PACKAGE
HK-CLW01-DIY	14mm socket & 8mm hex suitable For crank bolts & crank arms removal.	Orange	1 Pc/ Card



FORGED "O" SPOKE ADJUSTER

ITEM NO.	DESCRIPTION	PACKAGE
HK-SA01-DIY	8 grooves for spoke tension adjustment on 10~15 G nipples.	1 Pc/ Card



END PRESS

ITEM NO.	DESCRIPTION	COLOR	PACKAGE
HK-INS001-DIY	Tools for hydraulic hose fitting, easily to combine hoses and fittings.	Black	1 Pc/ Box

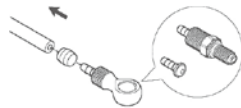

Push-on either banjo ends, inserts or straight connectors onto the hose with the bushing in place.

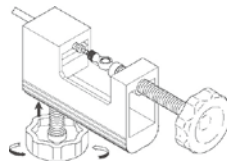

Place the assembly onto the end press as shown above.

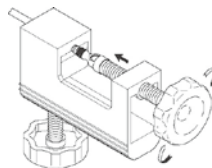

Tighten clamp and rotate lever slowly until the fittings are fully inserted. (Be sure that the hose is secure while rotating)

FACELIFT™



















ITEM NO.	DESCRIPTION	PACKAGE
HK-FL01-DIY	A mounting disc facing tool for I.S. 2000 front & rear, boxer and 20mm thru-axle frames and forks.	1 Set/ Carrying Box



UNIVERSAL BLEEDING KIT



HK-UBK001

ITEM NO.	DESCRIPTION						PACKAGE
HK-UBK001	Including all types of fitting, easily for you to change all models of hydraulic disc brake systems.						1 Set/ Carrying Box
							
GLOVES X 2	TUBE	TUBE	TUBE	WRENCH	HOPE		
							
MAGURA	AVID	HAYES	HAYES	FORMULA	FORMULA		
							
FORMULA	FORMULA	FORMULA	GATORBRAKE	SYRINGE (DOT)	SYRINGE (MIN)		

QUICK BLEED™

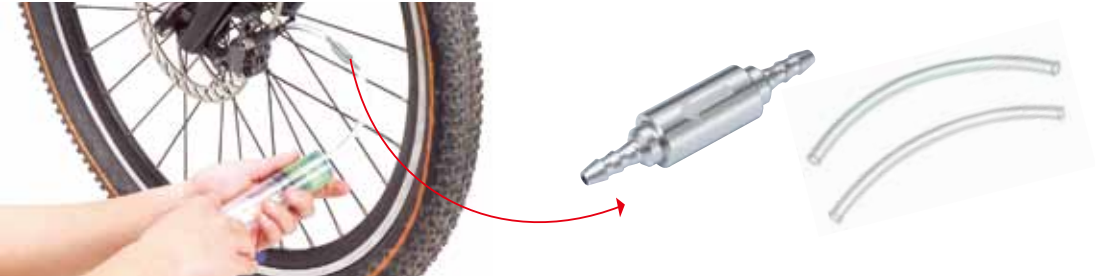
ITEM NO.	DESCRIPTION	PACKAGE
HK-QB01-DIY	Bleed disc brake system with ease internal valve mechanism prevents air being drawn into the system. Include: 1 pc quick bleed with 2 tubes.	1 Set/ Card
		

SHIMANO LEVER RESERVOIR FITTING

ITEM NO.	DESCRIPTION	PACKAGE
HK-SSP0024-DIY	Replacing the original Shimano lever reservoir fitting, much easier for bleeding.	1 Pc / Card

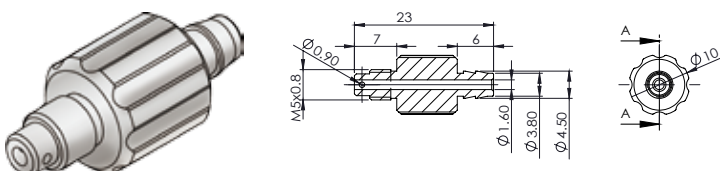



HYDRAULIC BRAKE FLUID

MINERAL OIL

- High viscosity index hyper performance hydraulic mineral oil.
- Suitable for all mineral based hydraulic disc brake.

ITEM NO.	DESCRIPTION	Q'TY
HK-OIL100	Mineral Oil	1000 ml
HK-OIL010	Mineral Oil	100 ml

D.O.T 4 & D.O.T 5.1

- Hyper-performance brake fluid. Suitable for all D.O.T. base disc brake system.

ITEM NO.	DESCRIPTION	Q'TY
HK-OIL100-4	D.O.T 4 Oil	1000 ml
HK-OIL010-4	D.O.T 4 Oil	100 ml
HK-OIL100-51	D.O.T 5.1 Oil	1000 ml
HK-OIL010-51	D.O.T 5.1 Oil	100 ml



1000ml

100ml



THE GRIPPER™

- Easy to install.
- Fit up to 6mm hydraulic hose.



BOTTLE



CARD

GRIPPER I

ITEM NO.	DESCRIPTION	COLOR	MATERIAL	Q'TY
HK-51-DIY	Stick on	Black	Polymer	2 Pcs/ Card
HK-51#B10	Stick on	Black	Polymer	10 Pcs/ Bottle



GRIPPER II

ITEM NO.	DESCRIPTION	COLOR	MATERIAL	Q'TY
HK-26-DIY	Zip-Tie	Black	Polymer	2 Pcs/ Card
HK-26#B12	Zip-Tie	Black	Polymer	12 Pcs/ Bottle



GRIPPER III

ITEM NO.	DESCRIPTION	COLOR	MATERIAL	Q'TY
HK-10-DIY	Screw on	Black	Anodized Alloy	2 Pcs/ Card
HK-10-1-DIY	Screw on	Silver	Anodized Alloy	2 Pcs/ Card



S-HOLDER

ITEM NO.	DESCRIPTION	COLOR	MATERIAL	Q'TY
LY-HPP06-DIY	S type cable holder	Black	Plastic	4 Pcs / PE Bag
LY-HPP06#B50	S type cable holder	Black	Plastic	50 Pcs / Bottle

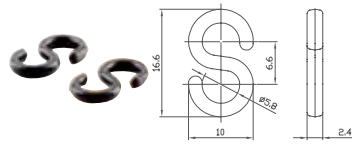

FRAME COMPONENTS

ITEM NO.	DESCRIPTION	COLOR	MATERIAL	Q'TY
LY-FPP01#B15	Cable strap 25.4 mm	Black	Plastic	15 Pcs/ Bottle
LY-FPP05#B50	C-Clip housing guide	Black	Plastic	50 Pcs/ Bottle









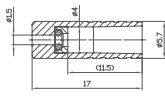

CABLE STOPPER

ITEM NO.	DESCRIPTION	COLOR	Q'TY
LY-CS01-DIY	Cable stopper	Black	2 Pcs/ PE Bag
LY-CS02-DIY	Cable stopper	Black	2 Pcs/ PE Bag

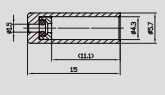

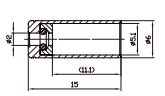

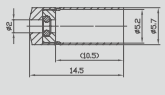

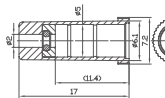





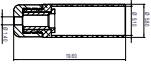

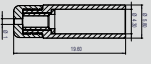

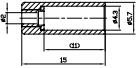

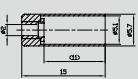

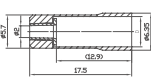

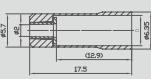

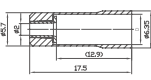

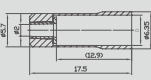

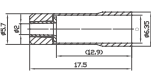

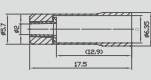

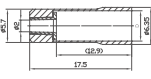

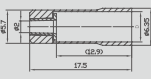

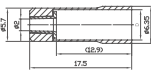

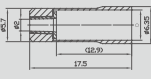
SEALED FERRULE

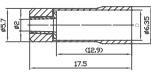
ITEM NO.	DESCRIPTION	COLOR	MATERIAL	QTY
LY-HPPS01#B150	 	Black	Plastic	150 Pcs/ Bottle
LY-HPA53BB#B100	 	Black	Anodized Alloy	100 Pcs/ Bottle
LY-HPA56BB#B100	 	Black	Anodized Alloy	100 Pcs/ Bottle
LY-HPBS01#150	 	Silver	Brass	150 Pcs/ Bottle
LY-HPPS02#100	 	Black	Plastic	100 Pcs/ Bottle

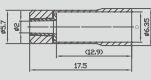

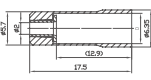

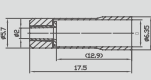





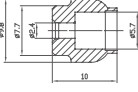

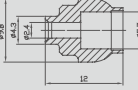

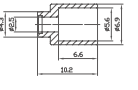

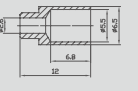

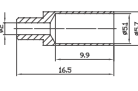

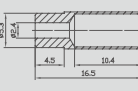
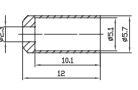

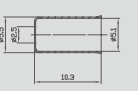

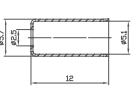
ALLIGATOR® | PARTS AND ACCESSORIES

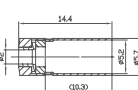
BASIC WATER-RESISTANT FEERULE

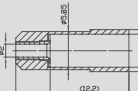
ITEM NO.		DESCRIPTION	COLOR	MATERIAL	QTY	
LY-HPA-22#B100			Dual guard Ferrule For Brake	Silver	Rubber/ Anodized Alloy	100 Pcs/ Bottle
LY-HPA-23#B100			Dual guard Ferrule For forward installed Shift housing	Silver	Rubber/ Anodized Alloy	100 Pcs/ Bottle
LY-HPA53BB-1#B150			Lined Ferrule 4.3 X 5.7 X 15 mm	Black	Plastic/ Anodized Alloy	150 Pcs/ Bottle
LY-HPA56BB-1#B150			Lined Ferrule 5.1 X 6 X 15 mm	Black	Plastic/ Anodized Alloy	150 Pcs/ Bottle
LY-HPA09#B100			Lined Ferrule 5.2 X 6.35 X 17.5 mm	Silver	Plastic/ Anodized Alloy	100 Pcs/ Bottle
LY-HPA09-1#B100			Lined Ferrule 4.3 X 6.35 X 17.5 mm	Silver	Plastic/ Anodized Alloy	100 Pcs/ Bottle
LY-HPA09-BK#B100			Lined Ferrule 5.2 X 6.35 X 17.5 mm	Black	Plastic/ Anodized Alloy	100 Pcs/ Bottle
LY-HPA09-1-BK#B100			Lined Ferrule 4.3 X 6.35 X 17.5 mm	Black	Plastic/ Anodized Alloy	100 Pcs/ Bottle
LY-HPA09-GD#B100			Lined Ferrule 5.2 X 6.35 X 17.5 mm	Gold	Plastic/ Anodized Alloy	100 Pcs/ Bottle
LY-HPA09-1-GD#B100			Lined Ferrule 4.3 X 6.35 X 17.5 mm	Gold	Plastic/ Anodized Alloy	100 Pcs/ Bottle
LY-HPA09-RD#B100			Lined Ferrule 5.2 X 6.35 X 17.5 mm	Red	Plastic/ Anodized Alloy	100 Pcs/ Bottle
LY-HPA09-1-RD#B100			Lined Ferrule 4.3 X 6.35 X 17.5 mm	Red	Plastic/ Anodized Alloy	100 Pcs/ Bottle
LY-HPA09-BL#B100			Lined Ferrule 5.2 X 6.35 X 17.5 mm	Blue	Plastic/ Anodized Alloy	100 Pcs/ Bottle
LY-HPA09-1-BL#B100			Lined Ferrule 4.3 X 6.35 X 17.5 mm	Blue	Plastic/ Anodized Alloy	100 Pcs/ Bottle
LY-HPA09-GN#B100			Lined Ferrule 5.2 X 6.35 X 17.5 mm	Green	Plastic/ Anodized Alloy	100 Pcs/ Bottle
LY-HPA09-1-GN#B100			Lined Ferrule 4.3 X 6.35 X 17.5 mm	Green	Plastic/ Anodized Alloy	100 Pcs/ Bottle
LY-HPA09-OG#B100			Lined Ferrule 5.2 X 6.35 X 17.5 mm	Orange	Plastic/ Anodized Alloy	100 Pcs/ Bottle
LY-HPA09-1-OG#B100			Lined Ferrule 4.3 X 6.35 X 17.5 mm	Orange	Plastic/ Anodized Alloy	100 Pcs/ Bottle

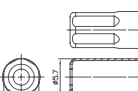
5 MM FERRULES

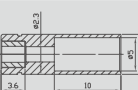
Pressed ferrule is suggested to be put on coiled structure cable housing.

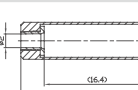
ITEM NO.		DESCRIPTION	COLOR	MATERIAL	QTY
LY-HPA01#B100		 Adapter (Road) 5.7 X 9.8 X 10 mm	Silver	Alloy	100 Pcs/ Bottle
LY-HPA02#B100		 Adapter (Universal) 5.7 X 9.8 X 12 mm	Silver	Alloy	100 Pcs/ Bottle
LY-HPS01#B200		 Adapter 5.6 X 6.9 X 10.2 mm	Silver	Steel	200 Pcs/ Bottle
LY-HPB01#200		 Adapter (Machined) 5.5 X 6.5 X 12 mm	Silver	Brass	200 Pcs/ Bottle
LY-HPB02#B150		 Adapter Ferrule (Machined) 5.1 X 5.7 X 16.5 mm	Silver	Brass	150 Pcs/ Bottle
LY-HPB03#B150		 Adapter Ferrule (Machined) 5.1 X 5.7 X 16.5 mm	Silver	Brass	150 Pcs/ Bottle
LY-HPB04#B200		 Ferrule (Machined) 5.1 X 5.7 X 12 mm	Silver	Brass	200 Pcs/ Bottle
LY-HPB06#B200		 0.2 Ferrule (Pressed) 5.1 X 5.6 X 12 mm	Silver	Brass	200 Pcs/ Bottle
LY-HPB07#B200		 0.3 Ferrule (Press) 5.1 X 5.7 X 12 mm	Silver	Brass	200 Pcs/ Bottle
LY-HPB09#B200		 Ferrule (Pressed) 5.1 X 5.6 X 12 mm	Black	Brass	200 Pcs/ Bottle
LY-HPB12#B150		 Lined Ferrule (Machined) 5.2 X 5.7 X 14.4 mm	Silver	Plastic/ Brass	150 Pcs/ Bottle
LY-HPB16#B120		 Lined Ferrule (Pressed) 5.1 X 6.5 X 17.5 mm	Silver	Plastic/ Brass	120 Pcs/ Bottle
LY-HPB23#B200		 Push Fit Ferrule (Pressed) 5.1 X 5.7 X 12.3 mm	Silver	Brass	200 Pcs/ Bottle
LY-HPA03#100		 Ferrule 5 X 6 X 18 mm	Silver	Alloy/ Plastic	100 Pcs/ Bottle
LY-HPA07#100		 Ferrule 5.1 X 5.7 X 20 mm	Silver	Plastic/ Anodized Alloy	100 Pcs/ Bottle

4 MM FERRULE

Pressed ferrule is suggested to be put on coiled structure cable housing.

ITEM NO.			DESCRIPTION	COLOR	MATERIAL	Q'TY
LY-HPB02-1#B200			Adapter Ferrule (Machined) 4.1 X 5 X 10 mm	Silver	Brass	200 Pcs/ Bottle
LY-HPB13#B200			Lined Ferrule (Machined) 4.1 X 4.7 X 12 mm	Silver	Brass	200 Pcs/ Bottle
LY-HPB13-1#B200			Lined Ferrule (Machined) 4.3 X 5.7 X 12 mm	Silver	Brass	200 Pcs/ Bottle
LY-HPB14#B200			Ferrule (Pressed) 4.1 X 4.5 X 10.8 mm	Silver	Brass	200 Pcs/ Bottle
LY-HPP01#B200			Ferrule (Shift) 4 X 5.6 X 12.2 mm	Black	Plastic	200 Pcs/ Bottle
LY-HPP02#B150			Ferrule (Shift) 4 X 5.7 X 17 mm	Black	Plastic	150 Pcs/ Bottle

TIP FERRULE

ITEM NO.			DESCRIPTION	COLOR	MATERIAL	Q'TY
LY-HPB11#B50			Tip Ferrule (Machined) 5.2 X 5.7 X 46.8 mm	White/ Silver	Plastic/ Brass	50 Pcs/ Bottle
LY-HPB15#B40			Tip Ferrule (Machined) 5.1 X 6.5 X 46.9 mm	Black/ Silver	Plastic/ Brass	40 Pcs/ Bottle
LY-HPA08#B60			Tip Ferrule 5.2 X 6.35 X 47.9 mm	Black/ Silver	Plastic/ Anodized Alloy	60 Pcs/ Bottle
LY-HPP05#B60			Tip Ferrule (Shift) 4.9 X 7 X 31.7 mm	Black/ Black	Plastic	60 Pcs/ Bottle
LY-HPPS03#B100			Tip Sealed Ferrule 4 X 5.7 X 27.5 mm	Black/ Black	Plastic	100 Pcs/ Bottle
LY-HPP03#B100			Tip Ferrule (Shift) 4 X 5.7 X 27.5 mm	Black/ Black	Plastic	100 Pcs/Bottle
LY-HPP07#B40			Tip Ferrule (Shift) 4.1 X 7 X 43.7 mm	Black/ Black	Plastic	40 Pcs/Bottle

INNER CABLE SHIELD

ITEM NO.			DESCRIPTION	COLOR	MATERIAL	Q'TY
LY-HPR01#B60			Rubber shield 40 mm	Black	Rubber	60 Pcs/Bottle
LY-VBP02#B60			Rubber shield 5 X 35 mm	Black	Rubber	60 Pcs/Bottle

END CAPS

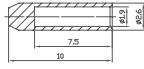
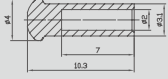
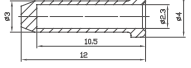
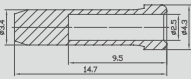
ITEM NO.	DESCRIPTION	COLOR	MATERIAL	Q'TY
LY-IPA01#B500	Cable end caps 1.9 mm for shift 	Silver	Alloy	500 Pcs/ Bottle
LY-IPA02#B500	Cable end caps 2.0 mm for Brake 	Silver	Alloy	500 Pcs/ Bottle
LY-IPA03#B500	Cable end caps 2.3 mm for Brake 	Silver	Alloy	500 Pcs/ Bottle
<p>Anodized Black Anodized Red Anodized Blue Anodized Green</p> <p>LY-IPA03-BK#B500 LY-IPA03-RD#B500 LY-IPA03-BL#B500 LY-IPA03-GR#B500</p> <p>Anodized Gold Anodized Pink Anodized Purple Anodized Orange</p> <p>LY-IPA03-GN#B500 LY-IPA03-PK#B500 LY-IPA03-PU#B500 LY-IPA03-MO#B500</p>				
LY-IPA04#B400	Cable end caps 2.5 mm for Brake 	Silver	Alloy	400 Pcs/ Bottle

CABLE BOLT

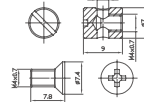
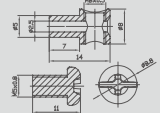
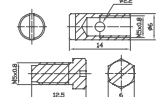
ITEM NO.	DESCRIPTION	COLOR	MATERIAL	Q'TY
LY-IPB01#B100	Cable bolt 2.6 mm 	Silver	Brass	100 Pcs/ Bottle
LY-IPB02#B100	Cable bolt 2.5 mm 	Silver	Brass	100 Pcs/ Bottle
LY-IPB02-1#B100	Cable bolt 2.2 mm 	Silver	Brass	100 Pcs/ Bottle











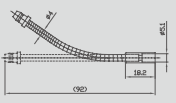

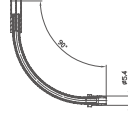
SHIFTING COMPONENTS

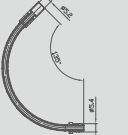
ITEM NO.	DESCRIPTION	COLOR	MATERIAL	Q'TY
LY-SPB01#B120	Threaded ferrule, Sturmey M4 X 5 X 6 X 16.7 mm 	Silver	Brass	120 Pcs/ Bottle
LY-SPB02#B50	Threaded ferrule, Shimano M5.5 X 5.8 X 7 X 16.5 mm 	Silver	Brass	50 Pcs/ Bottle
LY-SPB08#B30	Threaded connector, Sturmey 5 X 25 mm 	Silver	Brass	30 Pcs/ Bottle
LY-SPB05#B30	Threaded connector, Torpedo 5 X 25 mm 	Silver	Brass	30 Pcs/ Bottle
LY-SPB06#B30	Adjuster, Shimano M6 X 20 	Silver	Brass	30 Pcs/ Bottle
LY-SPB10-DIY	Tensioner, Torpedo compatible 	Black	Steel/ Plastic	1 Pc/ DIY Bag

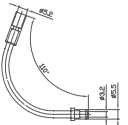
O-RINGS

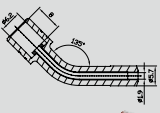
ITEM NO.		DESCRIPTION	COLOR	QTY
LY-IPR01#B200	 	Round, for Brake	Transparent	200 Pcs/ Bottle
LY-IPR06#B200	 	Round, for Shift	Transparent	200 Pcs/ Bottle
LY-IPR07#B200	 	Octagon, for Brake	Transparent	200 Pcs/ Bottle
LY-IPR02#B200	 	Octagon, for Shift	Transparent	200 Pcs/ Bottle
LY-IPR03#B200	 	Round, for Brake	Black	200 Pcs/ Bottle
LY-IPR05#B200	 	Round, for Shift	Black	200 Pcs/ Bottle
LY-IPR08#B200	 	Octagon, for Brake	Black	200 Pcs/ Bottle
LY-IPR04#B200	 	Octagon, for Shift	Black	200 Pcs/ Bottle

GUIDE PIPES

ITEM NO.		DESCRIPTION	COLOR	MATERIAL	QTY
LY-VBP08#P10	 	Flexible Guide Pipe $\varnothing 5.1$	Stainless Steel	Silver	10 Pcs/ Bag
LY-VBP03#P10	 	Guide Pipe 90°	Stainless Steel	Silver	10 Pcs/ Bag
LY-VBP04#P10	 	Guide Pipe 135°	Stainless Steel	Silver	10 Pcs/ Bag
LY-VBP07#P10	 	Guide Pipe 110°	Stainless Steel	Silver	10 Pcs/ Bag
LY-VBP09#P10	 	Guide Pipe 58°	Alloy	Silver	10 Pcs/ Bag
	    Black Red Blue Gold LY-VBP09-BK#P10 LY-VBP09-RD#P10 LY-VBP09-BL#P10 LY-VBP09-GD#P10				

INLINE SHIFT ADJUSTER SET

- Adjustment for derailleur to improve the accuracy.
- Foolproof design to prevent over adjusting.
- Suitable for the housing between 4mm-5mm
- Optional colors for the appearance.







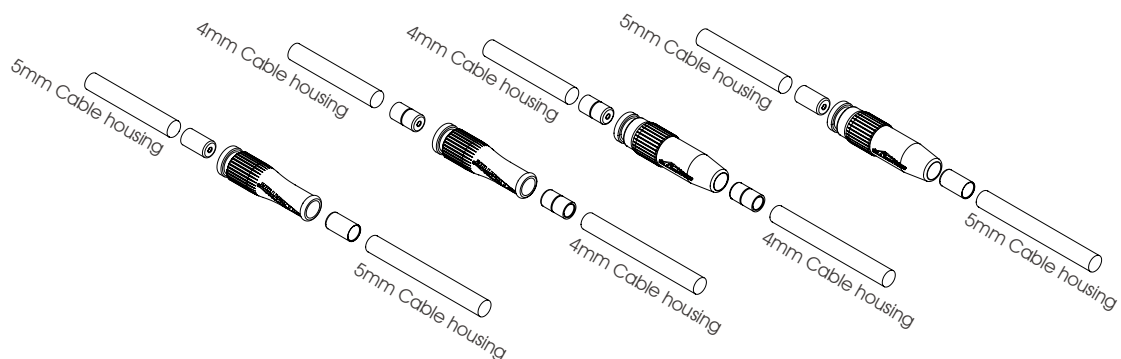



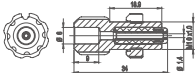

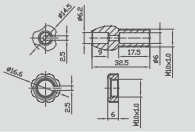
ITEM NO.	ACCESSORIES	COLOR	QTY
LY-IA02YS-DIY		Silver / Gold	2 Pcs/ Card
LY-IA02BK-DIY		Black	2 Pcs/ Card
LY-IA02RD-DIY		Red	2 Pcs/ Card
LY-IA02BR-DIY		Red / Black	2 Pcs/ Card
LY-IA02BS-DIY		Silver / Black	2 Pcs/ Card
LY-IA03CF-DIY		Brown	2 Pcs/ Card
LY-IA03BK-DIY		Black	2 Pcs/ Card

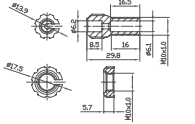

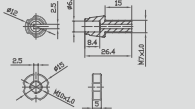

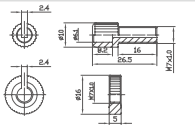
INSTALLATION INSTRUCTION

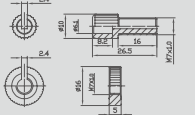



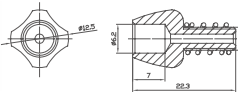





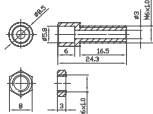

LEVER ADJUSTER

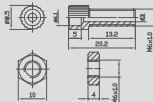
ITEM NO.		DESCRIPTION	COLOR	MATERIAL	QTY	
LY-LPA09#B10			Weatherproof Lever Adjuster M10 X 32 mm	Black	Anodized Alloy	10 Pcs/ Bottle
LY-LPA02-1#B10			Lever Adjuster M10 X 17.5 mm	Silver	Anodized Alloy	10 Pcs/ Bottle
LY-LPA03#B10			Lever Adjuster M10 X 16 mm	Black/ Silver	Anodized Alloy	10 Pcs/ Bottle
LY-LPA07#B10			Lever Adjuster M7 X 15 mm	Silver	Anodized Alloy	10 Pcs/ Bottle
LY-LPS01#B15			Lever Adjuster M7 X 16 mm	Silver	Steel	15 Pcs/ Bottle
LY-LPS02#B15			Lever Adjuster M7 X 16 mm	Plated Black	Steel	15 Pcs/ Bottle

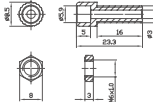
INDEX ADJUSTER

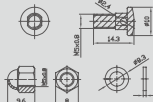
ITEM NO.	DESCRIPTION	COLOR	MATERIAL	QTY		
LY-ADJ01#B40			Index adjuster	Gold	Anodized alloy/ Stainless	40 Pcs/ Bottle
LY-ADJ02#B40		Gray				
LY-ADJ03#B40		Red				
LY-ADJ04#B40		Blue				
LY-ADJ05#B40		Black				

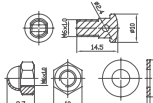
ADJUSTING SCREWS

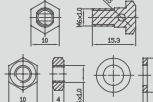
ITEM NO.	DESCRIPTION	COLOR	MATERIAL	QTY		
LY-CPA01#1#B40			Adjusting screw M6 X 16.5 mm	Silver	Anodized Alloy	40 Pcs/ Bottle
LY-CPS-01#1#B50			Adjusting screw M6 X 13.2 mm	Silver	Steel	50 Pcs/ Bottle
LY-CPS-03#1#B40			Adjusting screw M6 X 16 mm	Silver	Steel	40 Pcs/ Bottle
LY-CPS-05#1#B50			Screw bolt M5	Silver	Steel	50 Pcs/ Bottle
LY-CPS-06#1#B40			Screw bolt M6	Silver	Steel	40 Pcs/ Bottle
LY-CPS-07#1#B40			Screw bolt M6	Silver	Steel	40 Pcs/ Bottle



SILICONE HOUSING SHIELD



BOTTLE







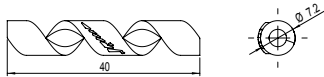



DIY Bag

SPIRAL TYPE DESCRIPTION QTY



Spiral type, for 4~5 mm housings

4 Pcs/ Bag
20 Pcs/ Bottle

White  LY-HPR13-WH#P4 LY-HPR13-WH#B20	Black  LY-HPR13-BK#P4 LY-HPR13-BK#B20	Red  LY-HPR13-RD#P4 LY-HPR13-RD#B20	Blue  LY-HPR13-BL#P4 LY-HPR13-BL#B20	Yellow  LY-HPR13-YW#P4 LY-HPR13-YW#B20
Orange  LY-HPR13-OR#P4 LY-HPR13-OR#B20	Green  LY-HPR13-GR#P4 LY-HPR13-GR#B20	Pink  LY-HPR13-PK#P4 LY-HPR13-PK#B20	Purple  LY-HPR13-PU#P4 LY-HPR13-PU#B20	

SAWTOOTH TYPE DESCRIPTION QTY

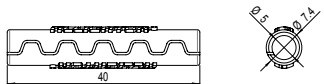

Saw-tooth type for 5 mm housings

4 Pcs/ Bag
20 Pcs/ Bottle





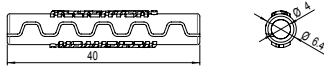



White  LY-HPR12-WH#P4 LY-HPR12-WH#B20	Black  LY-HPR12-BK#P4 LY-HPR12-BK#B20	Red  LY-HPR12-RD#P4 LY-HPR12-RD#B20	Blue  LY-HPR12-BL#P4 LY-HPR12-BL#B20	Yellow  LY-HPR12-YW#P4 LY-HPR12-YW#B20
Orange  LY-HPR12-OR#P4 LY-HPR12-OR#B20	Green  LY-HPR12-GR#P4 LY-HPR12-GR#B20	Pink  LY-HPR12-PK#P4 LY-HPR12-PK#B20	Purple  LY-HPR12-PU#P4 LY-HPR12-PU#B20	

SAWTOOTH TYPE DESCRIPTION QTY



Saw-tooth type for 4 mm housings

4 Pcs/ Bag
20 Pcs/ Bottle

White  LY-HPR11-WH#P4 LY-HPR11-WH#B20	Black  LY-HPR11-BK#P4 LY-HPR11-BK#B20	Red  LY-HPR11-RD#P4 LY-HPR11-RD#B20	Blue  LY-HPR11-BL#P4 LY-HPR11-BL#B20	Yellow  LY-HPR11-YW#P4 LY-HPR11-YW#B20
Orange  LY-HPR11-OR#P4 LY-HPR11-OR#B20	Green  LY-HPR11-GR#P4 LY-HPR11-GR#B20	Pink  LY-HPR11-PK#P4 LY-HPR11-PK#B20	Purple  LY-HPR11-PU#P4 LY-HPR11-PU#B20	

SOLID TYPE DESCRIPTION QTY



Solid type for 5 mm housings

4 Pcs/ Bag
20 Pcs/ Bottle

Orange  LY-HPR05#P4 LY-HPR05#B20
--

SPECIAL CABLES AND WIRES



ALLIGATOR is specialized in all control cables, manufacturing cables and wires not only for bicycle, also for motorcycle, automobile, ATV, medical equipments, and agricultural facilities... etc. We will keep providing the best quality to satisfy your request. ALLIGATOR, ALWAYS BETTER.



YLA-AL-CARBON-OR
Frame Protectors



LY-MBL01
ALLIGATOR-MESH Bracelet

ALLIGATOR WILL ALWAYS BE WITH YOU.



ALLIGATOR[®]
ALLIGATOR CABLES & WIRE



LIU YIH CABLE ENT. CO., LTD.

No. 46, Tung Koo Rd., Homei, Chang Hua, Taiwan
TEL: 886-4-7357739 FAX: 886-4-7353665
E-mail: info@alligatorcables.com
www.alligatorcables.com